



A LIFETIME OF SECURITY

LightSYS Plus

Installation and Programming Manual



For more information about RISCO Group's branches, distributors and full product line, please visit riscogroup.com



Important Notice

This guide is delivered subject to the following conditions and restrictions:

This guide contains proprietary information belonging to RISCO Group. Such information is supplied solely for the purpose of assisting explicitly and properly authorized users of the system. No part of its contents may be used for any other purpose, disclosed to any person or firm, or reproduced by any means, electronic or mechanical, without the express prior written permission of RISCO Group.

The information contained herein is for the purpose of illustration and reference only.

Information in this document is subject to change without notice. Corporate and individual names and data used in examples herein belong to their respective owners.

© RISCO Group 2022. All rights reserved. No part of this document may be reproduced in any form without prior written permission from the publisher.

Contents

INTRODUCTION	10
SYSTEM ARCHITECTURE	11
SYSTEM CAPABILITIES	11
MAIN FEATURES	15
<i>Live Video Verification with VUpoint IP Cameras</i>	15
<i>Flexible Communication Options</i>	16
<i>Advanced Communication Modules</i>	16
<i>Multiple Reporting Destinations</i>	16
<i>Cloud Communication</i>	16
Monitoring, Notification, Operation and Control via the RISCO Cloud	17
<i>Enhanced Capabilities of Multi-Socket Communication Modules</i>	18
<i>Parallel Communication</i>	19
<i>Backup Communication</i>	19
<i>RISCO Bus Configurations</i>	20
<i>System Configuration Interfaces</i>	20
<i>Installation and Device Allocation Tools</i>	20
<i>Diagnostic Tests and Maintenance Features</i>	20
<i>Event Logging</i>	21
<i>Programmable Outputs</i>	21
<i>False Alarm Reduction Features</i>	21
<i>Home Automation</i>	21
SAFETY WARNINGS AND PRECAUTIONS	22
INSTALLATION	23
MAIN TASKS FOR INITIAL SYSTEM SETUP	23
STEP 1: CREATING A PLAN FOR MOUNTING THE SYSTEM	24
<i>Main Panel Mounting Considerations – Wireless Systems</i>	24
RF Signal Loss Due to Common Building Materials	25
Central Mounting Location – Wireless Systems.....	25
STEP 2: WIRING, SETTINGS, AND MODULE INSTALLATIONS AT THE MAIN PANEL	26
<i>Power Supply, Ground</i>	26
<i>Main Panel Wiring Diagram</i>	28
<i>Replacing the Main Panel PCB</i>	29
<i>Describing Connectors & Ports on the Main Panel PCB</i>	30
<i>RESET Button</i>	31

<i>Installing Plug-In Communication and Audio Modules</i>	31
Installing a GSM Module.....	31
Connecting to IP	32
Connecting to Wi-Fi	32
Installing an LRT Module.....	32
Installing the Voice Module	33
Installing the Listen-In & Speak Unit.....	34
<i>Wiring other Devices at the Terminal Block.....</i>	34
Connecting a Wired Keypad.....	34
Connecting Auxiliary (12 V DC) Devices	34
Connecting the Bell / Loudspeaker	35
Connecting the Bell Tamper.....	35
Connecting the Box Tamper (Wall Tamper)	35
Connecting 4-Wire Smoke Detectors	36
STEP 3: BUS LINE INSTALLATIONS.....	37
<i>Bus Line Wiring</i>	37
<i>Describing Bus Devices</i>	37
<i>Describing Bus Detectors and their Connection Options</i>	37
<i>Typical Wired Expansion Modules Installed on RISCO Bus Lines</i>	38
<i>Describing Installer-Set ID Numbers for Bus Devices.....</i>	39
ID Number Formats	40
Assigning ID Numbers (Setting DIP Switches) for Bus Devices	41
<i>Installing Bus Devices</i>	42
Installing Wired Keypads.....	42
Installing Bus Detectors	42
Installing Bus Zone Expanders	43
Connecting Multiple Bus Detectors using Bus Zone Expanders.....	43
Installing Power Supply Expansion Modules.....	44
Installing Utility Output Expansion Modules	45
Installing Wireless Expanders.....	45
Installing Bus Sounders (Sirens).....	45
STEP 4: CONNECTING RELAY DETECTORS	46
<i>Installing Zone Expanders.....</i>	47
<i>Defining Zone Termination Resistance</i>	47
<i>Wiring Resistors for Zone Termination Resistance.....</i>	48
Zone Termination Configuration Options	48
STEP 5: CONNECTING THE BACKUP BATTERY AND MOUNTING THE MAIN PANEL	49
<i>Connecting the Backup Battery</i>	49
Mounting the Main Panel.....	49



SYSTEM INITIALIZATION, DEVICE ALLOCATIONS & GENERAL SYSTEM CONFIGURATION50

- STEP 1: DESCRIBING KEYPAD CONTROLS AND INSTALLER MENUS 50
 - Describing Dynamic Keypad Menus*..... 50
 - Table of Keypad Buttons 50
 - Designating Labels 51
 - Entering the Installer Programming Menu at Initial System Setup*..... 51
- STEP 2: POWERING-UP AND INITIALIZING THE SYSTEM.....51
 - System Power-Up and Language Selection* 51
 - Defining Partitions*..... 52
 - Keypad Timeout 52
 - Defining Partitions after Initialization..... 52
- STEP 3: ALLOCATING AND CONFIGURING INSTALLED COMPONENTS.....53
 - Auto-Setting Scan for Communication Modules & Bus Devices* 53
 - Describing Auto-Setting Results 54
 - Performing a Bus Test* 54
 - Manually Allocating & Configuring Communication Modules* 55
 - GSM Modules 55
 - Entering or Deleting a SIM Card PIN 55
 - Defining APN Automatically and Manually 56
 - Setting Dynamic IP / Static IP 56
 - Long-Range Radio Transmitter Module 56
 - Cellular On Bus (COB)..... 56
 - Manually Allocating and Configuring STU Adapter 56
 - Manually Allocating & Configuring other Modules and Bus Devices* 57
 - Wired Keypads 57
 - Zone Expanders 58
 - Utility Output Modules 58
 - Power Supply Modules 59
 - Wireless Expanders 59
 - Wireless Video Expanders 59
 - Wireless Security Modules 60
 - Proximity Key Readers 60
 - Voice Module 60
 - Sounders (Sirens)..... 61
 - Bus Zones (Bus Detectors)..... 61
 - Bus Zone Expanders 62
- STEP 4: ALLOCATING WIRELESS ZONES 62
 - Allocating Wireless Expanders*..... 62
 - Allocating Wireless Devices* 63

Allocating Wireless Devices via RF Transmission	63
Wireless Device RF Transmissions.....	64
Allocating Wireless Devices via Code	65
STEP 5: BASIC ZONE CONFIGURATION FOR ALL ZONE TYPES	66
<i>Defining Basic Parameters</i>	66
Describing Zone Information Displayed at the Keypad.....	66
Defining Zone Parameters using the “One-By-One” Option	67
Defining Zone Parameters using the “By Category” Option.....	68
Defining Zone Termination Resistance using the “Resistance” Option.....	68
STEP 6: ADVANCED ZONE CONFIGURATION FOR BUS ZONES AND WIRELESS ZONES.....	69
<i>Advanced Programming for Wireless Zones</i>	69
Measuring Background Noise Level and Defining the Threshold Limit	70
Performing a Wireless Comm. Test for Measuring Signal Strength	71
STEP 7: CONFIGURING SYSTEM COMMUNICATION.....	72
<i>Defining Primary Communication Channels & Parameters</i>	72
<i>Defining Communication with the Monitoring Station</i>	73
Enabling Monitoring Station Communication	73
Defining Monitoring Station Account Parameters	73
STEP 8: CONFIGURING CLOUD CONNECTIVITY	74
<i>Enabling / Disabling Cloud Communication</i>	74
<i>Defining RISCO Cloud Connectivity</i>	74
STEP 9: CONFIGURING COMMON SYSTEM PARAMETERS.....	75
<i>Defining System Users</i>	75
Defining User Codes	75
Changing the Default Installer Code	76
Changing the Default Grand Master Code	76
Resetting the Installer, Sub-Installer and Grand Master Codes to Default Codes	76
<i>Defining Follow Me Destinations</i>	77
Enabling Follow Me	77
Defining Follow Me Parameters	77
<i>Defining System Timers</i>	77
<i>Defining All Additional Parameters</i>	77
INSTALLER PROGRAMMING.....	79
DEFINING PARAMETERS – INSTALLER PROGRAMMING MENU	79
① <i>System</i>	80
①① Timers	80
①② Controls.....	83
①③ Labels	100
①④ Sounds.....	101

①⑤ Settings	102
①⑥ Automatic Clock.....	106
①⑦ Service Information.....	106
①⑧ Firmware Update	106
② Zones	107
②① Parameters.....	108
One-By-One.....	108
By Category.....	108
Bus Zone: OPR12 (WatchOUT PIR)	123
Bus Zone: iWISE DT Grade 2	124
Bus Zone: (Industrial) Lunar /BWare/iWISE DT Grade 3	125
Bus Zone: iWISE QUAD Grade 2	126
Bus Zone: iWISE/BWare QUAD Grade 3	127
Bus Zone: ODT15 (WatchOUT DT).....	128
Bus Zone: WatchIN DT Grade 3	129
Bus Zone: Seismic.....	130
Wireless Zones: 1-Way and 2-Way Smoke.....	132
Wireless Zones: 2-Way PIR, WatchOUT and Wireless IR Beam	132
Wireless Zones: 2-Way Magnetic Contact Detector (X73).....	133
Presence	135
Resistance	136
②② Testing	137
②③ Cross Zones.....	139
②④ Alarm Confirm	141
③ Outputs	142
③① Nothing.....	142
③② System.....	143
③③ Partition	146
③④ Zone	150
③⑤ Code	152
Pattern of Operation for Utility Outputs.....	153
Latch N/O & Latch N/C	153
Pulse N/O & Pulse N/C	153
③⑥ STU Testing.....	154
④ Codes	154
④① User	154
④② Grand Master	156
④③ Installer	157
④④ Sub Installer	157
④⑤ Code Length.....	157
⑤ Communication.....	158
⑤① Method.....	158

⑤② Monitoring Station	172
⑤③ Configuration SW	187
⑤④ Follow Me	189
⑤⑤ Cloud	195
⑥ Audio	197
⑥① Messages	198
⑥② Local Announcements	200
⑦ Install	201
⑦① Bus Devices	201
⑦② Wireless Devices	207
⑧ Devices	208
⑧① Keypad	208
⑧② Keyfob	209
⑧③ Sounder	210
⑧④ Proximity Key Reader	215
⑧⑤ Power Supply	215
@ Exit	217
EXITING INSTALLER PROGRAMMING MENU	217
<i>Exiting Installer Programming Menu after Initial System Programming</i>	217
RESTORING MANUFACTURER'S PROGRAMMING DEFAULTS	219
DEFINING PARAMETERS – ADDITIONAL INSTALLER MENUS	220
<i>Activities Menu</i>	220
<i>Follow Me Menu</i>	221
<i>View Menu</i>	222
<i>Clock Menu</i>	222
<i>Event Log Menu</i>	224
<i>Maintenance Menu</i>	224
<i>Macro Menu</i>	225
<i>Stand Alone Keyfob Menu</i>	226
TESTING THE SYSTEM	227
INSTALLER RESPONSIBILITIES FOR ASSISTING THE CLIENT	228
APPENDIX A: TECHNICAL SPECIFICATION	229
APPENDIX B: WIRING	231
APPENDIX C: INSTALLER EVENT LOG MESSAGES	233
APPENDIX D: TROUBLESHOOTING	242
APPENDIX E: LIBRARY VOICE MESSAGES	245



APPENDIX F: MONITORING STATION REPORT CODES.....	246
APPENDIX G: REMOTE SOFTWARE UPGRADE.....	251
APPENDIX H: COMPLIANCE.....	253
APPENDIX I: LIGHTSYS PLUS ACCESSORIES	255
APPENDIX J: INSTALLER PROGRAMMING MAPS	260

Introduction

The ideal solution for residential, commercial, industrial, and enterprise sectors, LightSYS Plus is a Grade 3 compatible, super-hybrid security system that offers communication flexibility and advanced system control via Smartphone and Web user apps, scalable up to 512 zones – using various combinations of wired, bus, and wireless detectors and accessories. LightSYS Plus offers the following:

- ✓ Various system connectivity options, including via the RISCO Cloud – for user control, operation and notification via RISCO's Smartphone and Web user apps, for communicating and reporting to the monitoring station, and for utilizing RISCO's VUpoint IP cameras – for real-time, live video verification of events
- ✓ One or more multi-socket communication modules (IP, GSM 2G, GSM 3G or GSM 4G) that provide multiple, simultaneous communication channels for direct communication, and for communication via the Cloud
- ✓ Additional communication modules – multi-socket GSM/GPRS/2G/3G/4G and IP, as well as LRT module
- ✓ Hybrid system supporting installation of any combination of RISCO peripherals: wireless devices (1-way, 2-way), bus devices, and wired relay detectors
- ✓ Three independent RISCO bus lines (RS485 cables) that support a multitude and variety of bus-connected RISCO peripherals and expansion modules, installed in maximally efficient topologies for saving on lengthy bus cable costs
- ✓ Selectable "end-of-line" termination resistance values, compatible also for retrofit installations utilizing relay detectors of various termination resistance values
- ✓ Auto-Install™ technology (Auto Setting bus scanning feature) for providing quick allocation and configuration of system-connected communication modules and bus-connected devices
- ✓ Advanced tests and diagnostics for the system and for individual peripherals
- ✓ Compatibility for multi-site projects with SynopSYS – RISCO's "In-House Central" Security Management Solution
- ✓ An IP/GSM Receiver package available for monitoring stations
- ✓ Support for SIA IP
- ✓ Advanced remote/local configuration & diagnostics via Configuration Software

System Architecture

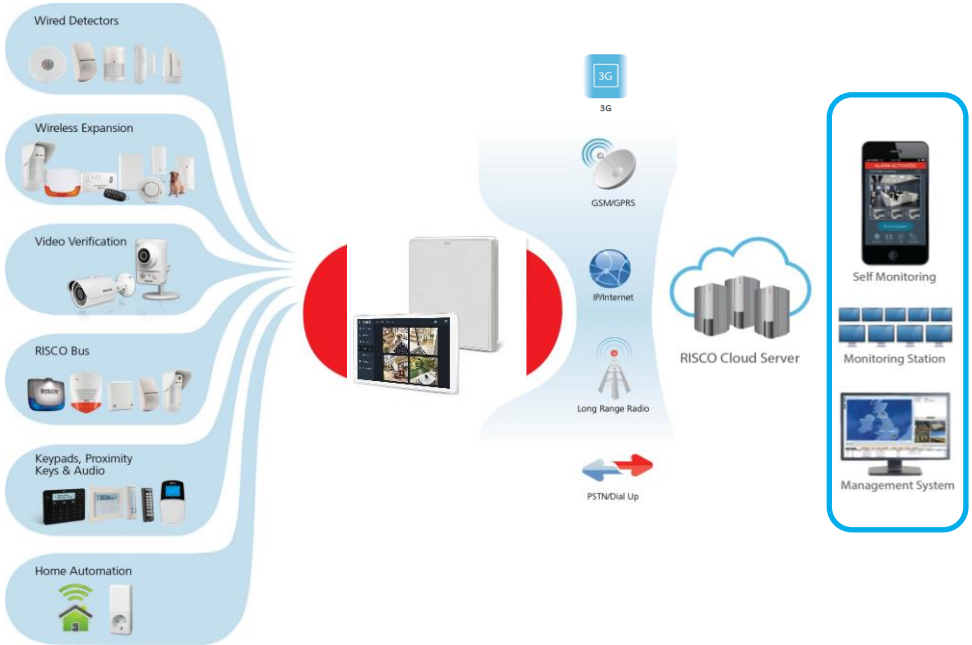

System Capabilities

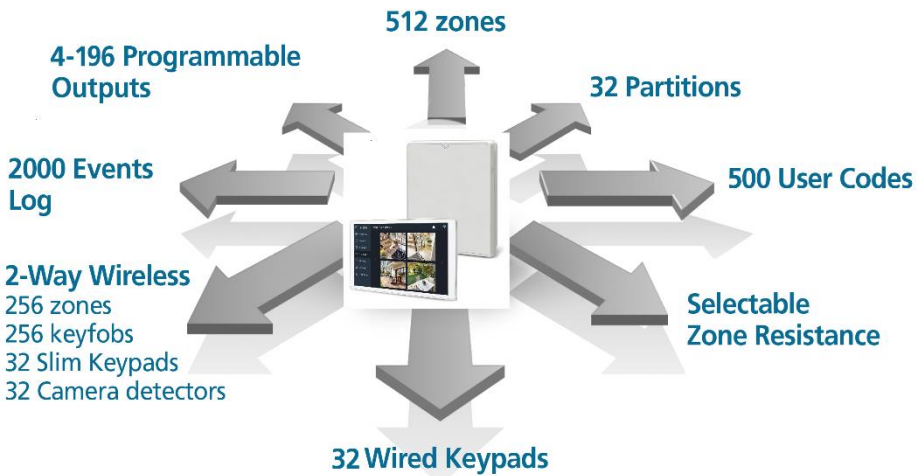

Main Capabilities	Description
Grade compatibility	Grade 2 and 3 (selectable)
Total zones	8-512 (8 on main panel terminal block) – all zones are fully supervised and programmable
Zone types	35
Bus zones	512
Hard wired zones	512
Wireless zones	256 (1-way & 2-way)
Partitions & groups	<ul style="list-style-type: none"> • 32 partitions (any zone can be associated to any partition) • Each partition supports zone sharing and cross zoning • Up to 4 groups per partition
RISCO bus lines (RS485)	3 (each independent of the others). Bus line 1 has a dedicated quick connector option on main panel PCB. Each bus supports up to 32 bus devices (128 total) Option for fast bus
Zone termination & resistance	<ul style="list-style-type: none"> • Fully selectable termination resistance values. • Five zone termination options available: normally closed (NC), normally open (NO), end-of-line resistance (EOL), double end-of-line resistance (DEOL), and triple-end-of-line-resistance (TEOL)
Utility outputs	4 – 196, programmable (4 on main panel terminal block)
User codes	<ul style="list-style-type: none"> • 500 user codes, with choice of authority levels • 1 code each for installer, sub-installer and Grand Master
Event log	2000
Wired keypads	32
Wireless keypads	32
Wireless keyfobs	256 (1-way, 2-way) including panic keyfob
Proximity key readers	64
Bell tamper input	Yes (main panel terminal block)
Communication	<ul style="list-style-type: none"> • Multi-socket IP/Wi-Fi (built-in) • Multi-socket modules GSM-2G, GSM-3G and GSM-4G • STU module (UK) • LRT module (Long-range Radio Transmitter)
Audio Modules	<ul style="list-style-type: none"> • Voice Module • Listen-In & Speak Unit

Main Capabilities	Description
Expansion capabilities	<ul style="list-style-type: none"> • Wireless Expander (868MHz or 433MHz) • Bus Zone Expanders • Zone Expanders (for relay detectors): 8-zone, single-zone • Output Expanders (4 X 3A) • Power Supply Expanders (1.5A, 3A)
Monitoring station	Up to 3 accounts, direct connection using SIA IP, or via Cloud with the RISCO IP Receiver installed at the monitoring station
Reporting formats	Contact ID , SIA, SIA-IP
Follow-Me	Up to 64 destinations, reporting via SMS, E-mail, or voice
IP Receiver software	Yes
SynopSYS connectivity	By IP/GPRS/3G/4G
CS connectivity	Through various communication channels or direct connection
Power input	2.5A or 4.5A
Wired sirens	32
Wireless sirens	32
Automatic program scheduling	64

Compliance Statement

Hereby, RISCO Group declares that the LightSYS Plus is designed to comply with:

- EN50131-1
- EN50131-3 Grade 3, Environmental Class II for Housing RP512B and RP432BP3, EN50131-3 for Housing RP512B and RP432BP3, EN50131-3 Grade 2, Environmental Class II for Housing RP432BP
- EN50131-6 Type A
- EN50136-1
- EN50136-2
- EN50131-10 SPT Type Z
- PD6662:2017
- Compatibility with serial interface with AS
- Compatibility with GPRS protocol
- Compatibility with TCP/IP protocol

- Control Panel method of operation: Pass-through
- Signaling security: Substitution security S2
- Information security I3

Alarm Transmission System Classification and Categories:

- GSM 2G/3G/4G (SP5)
- IP/Wi-Fi (SP6)
- GSM primary and IP/ Wi-Fi secondary (DP4),
- IP/ Wi-Fi primary and GSM secondary (DP4)

EN50136 Compliance:

- RISCO has designed the LightSYS Plus IP And GSM communication modules to be in compliance with the information security and substitution security requirements of EN50136.

Notes:

- For RP512B and RP432BP3 INCERT compliance, due to Grade 3 considerations, the Max current consumption allowed to be delivered by the Control Panel shall be limited @ ~160 mA using 17.2Ah Battery.
- For RP432BP INCERT compliance, due to Grade 2 considerations, the Max current consumption allowed to be delivered by the Control Panel shall be limited @ ~165 mA using 7Ah Battery

Main Features

Live Video Verification with VUpoint IP Cameras

LightSYS Plus supports VUpoint – RISCO’s revolutionary, live video verification solution for residential and commercial installations that seamlessly integrates an unlimited number of IP cameras to provide an unprecedented level of security and live video monitoring capabilities for monitoring stations and end-users alike.

- VUpoint offers seamless integration of LightSYS Plus with IP cameras
- A unique solution that offers real-time video verification of alarms and events for monitoring stations, business & home owners
- Live video available on-demand
- VUpoint may be added to any LightSYS Plus system connected to the RISCO Cloud, and is not dependant on the firmware version installed
- Compatible also for Grade 3 installations



VUpoint Indoor Cube IP Camera



VUpoint Outdoor Bullet IP Camera

Powered by the RISCO Cloud, VUpoint enables live video streaming from IP cameras to be viewed “on-demand” using the iRISCO Smartphone or Web user application. VUpoint can be configured so that any event – intrusion, safety, or panic – can activate the IP camera.

For verification purposes, live viewing of video of events can greatly assist monitoring stations in identifying costly false alarms, and enabling a greater operational efficiency.

Download the iRISCO app from the Apple Store for iOS devices and the Play Store for Android devices. For more information contact your RISCO distributor or go to: www.riscogroup.com

Flexible Communication Options

LightSYS Plus offers a multitude of communication channels and reporting formats, enabling monitoring, notification & operation and maintenance for end users, installers and monitoring stations.

Advanced Communication Modules

System communication is enabled by easy-to-install plug-in GSM communication modules and a built-in IP module:

- **Multi-socket GSM 2G, GSM 3G and GSM 4G modules**
- **Multi-socket IP**
- **STU module (UK)**
- **LRT module**

Multiple Reporting Destinations

- **System Users:** System users can use the Cloud-based iRISCO smartphone and Web User interface for receiving event notifications. Also, multiple Follow-Me recipients are notified of events via voice (voice mail), SMS, or e-mail.
- **Monitoring Station:** Events are reported to monitoring station(s) directly or via the RISCO Cloud, in any of the supported channels. LightSYS Plus supports all major monitoring station reporting formats and protocols - including direct connection to the monitoring station using SIA IP, or via the Cloud with the RISCO IP Receiver installed at the monitoring station.
- **Installer:** According to how the system is programmed, installers can also receive Follow-Me reporting, just like system users.

Cloud Communication

Cloud communication is available either from a private server or hosted by the RISCO Cloud – RISCO's application server that enables communication to monitoring stations and to end users utilizing event reporting, self-monitoring and operational functions via the iRISCO Smartphone app and Web user interface. The Configuration Software can also be connected via the RISCO Cloud to perform remote system configuration and diagnostics.



Monitoring, Notification, Operation and Control via the RISCO Cloud

Self-Monitoring for System Users via Smartphone & Web Applications

Powered by the RISCO Cloud, the iRISCO Smartphone app and Web User Interface empower system users with self-monitoring, notification, control, and operation of their systems remotely – anywhere, anytime, with or without a monitoring station.

iRISCO Smartphone App

The iRISCO Smartphone app provides smart and easy control of the system, enabling on-the-go users to receive event notifications, view the system status and event history, arm/disarm the system, activate home automation devices, bypass zones, and utilize IP cameras for visual verification and self-monitoring. iRISCO is available for iOS and Android.

Web User Interface

RISCO's Web user interface enables system users to monitor, control and configure their system via their computer's Web browser. In addition to the capabilities of the iRISCO Smartphone app, the Web user interface enables registering the system, adding system users, and more.

Enhanced Capabilities of Multi-Socket Communication Modules

Multi-socket communication modules each provide multiple, simultaneous communication channels for services and reporting (for example to the user and monitoring station) – directly, or via the Cloud. Multi-socket module services and reporting abilities include:

- **iRISCO Smartphone app & Web user interface:** Connected via RISCO Cloud
- **Monitoring Station:** Direct connection using SIA-IP, or with the RISCO IP Receiver installed at the monitoring station
- **Configuration Software:** Connection with panel via RISCO Cloud or directly using various channels, including GSM & IP networks – see CS documentation
- **Follow-Me:** Events are sent to FM destinations by E-mail, SMS, or voice
- **SynopSYS:** Connection via IP/GPRS/3G/4G

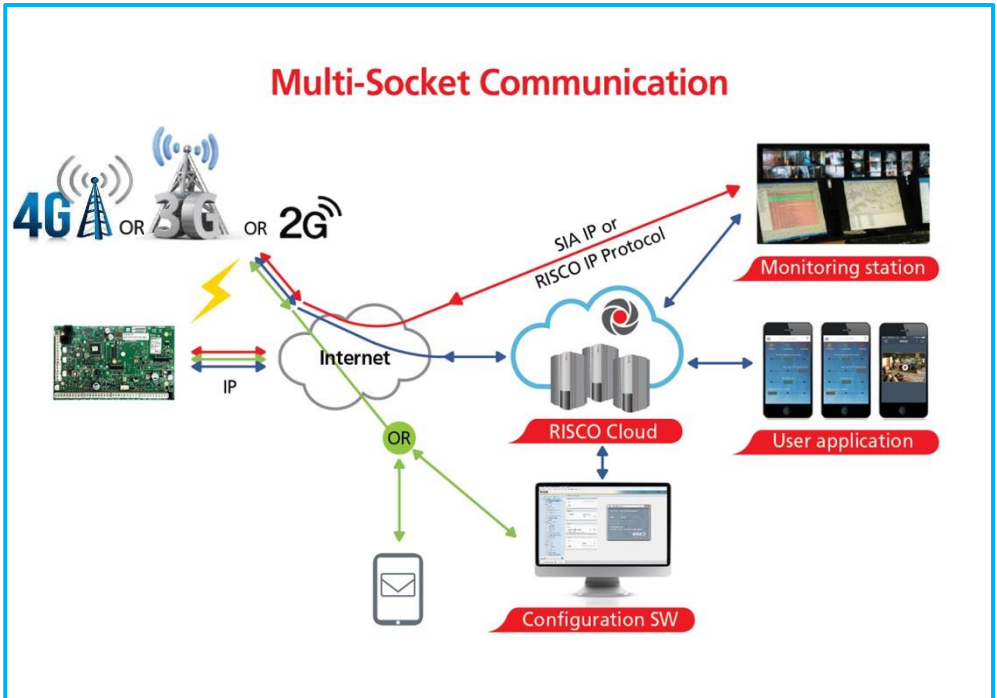

Parallel Communication

Parallel communication is accomplished using multiple communication channels (Wi-Fi/IP, GSM 2G, GSM 3G, GSM 4G) simultaneously (“in parallel”) – for example, for user reporting via the Cloud while simultaneously reporting to the monitoring station directly. If two multi-channels (Wi-Fi/IP and GSM) are installed, each channel provides its own parallel communication capabilities.

Backup Communication

Backup communication can be accomplished as follows:

- **If using multi-socket modules** (Wi-Fi/IP, GSM 2G, GSM 3G, GSM 4G), any individual multi-socket installed can provide multiple, simultaneous communication channels with a variety of reporting frameworks, both directly and through the RISCO Cloud – for example, one channel reporting to the user via the Cloud, while the other channel simultaneously reporting directly to the monitoring station. If both Wi-Fi/IP and GSM multi-sockets are installed, when utilizing direct communication either of the modules can take over and connect as a communication failure backup if the other fails.

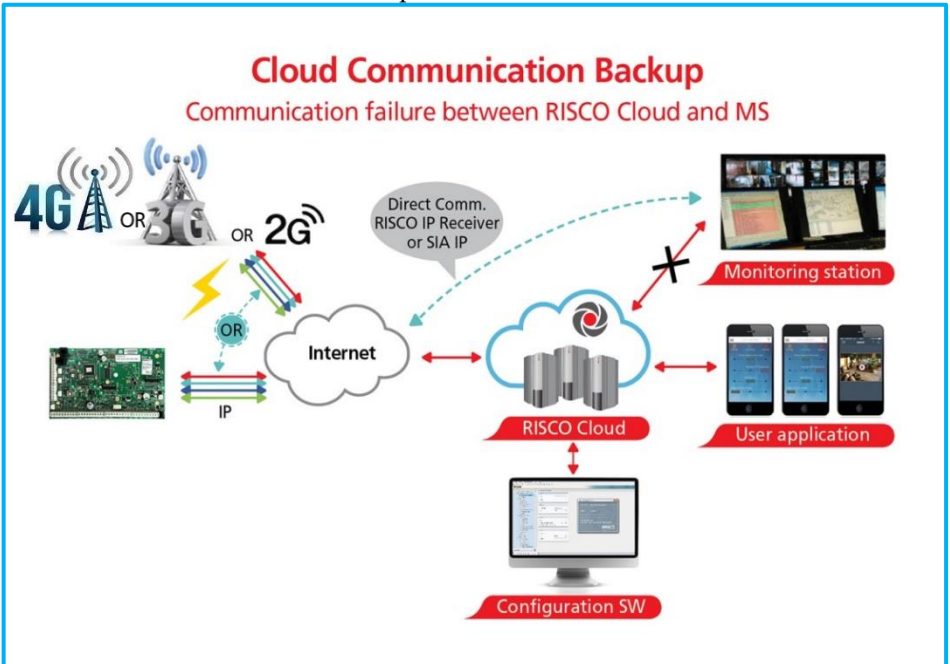

RISCO Bus Configurations

The LightSYS Plus provides 3 independent RISCO Bus lines (RS485) for communicating and powering bus-connected devices (expansion modules, detectors, sounders, and other peripheral devices). The RISCO bus configurations can be in any combination of daisy chain, spur or star topologies.

System Configuration Interfaces

- **Wired keypad**
- **Configuration Software**

Installation and Device Allocation Tools

- **Auto Setting:** This feature scans the bus lines to find all installed communication modules and bus devices in the system. As you view the results, you allocate (enable) each, and then you can configure their settings on-the-fly, or later during installer programming.
- **Bus Test:** This test finds each installed bus device and communication module to verify adequate bus connectivity and communication quality on a scale of 0—100%, whereas a result of 97% or less means there is a bus connection problem. Results are individually displayed on the keypad or the Configuration Software.
- **Background noise-level threshold & calibration:** For wireless devices, you can measure (“calibrate”) the background noise that the main panel detects (to provide an indication whether the main panel is mounted at a good location), and also define the acceptable threshold value (to decide how much background noise your system will tolerate before it generates jamming events).
- **Wireless Communication Test:** This tests and displays the signal strength between the wireless device tested and the main panel, as an indicator of whether the mounting location of the wireless device is adequate.

Diagnostic Tests and Maintenance Features

Various tests are available to perform during and after installation, such as the **Walk Test**, **Follow-Me Test**, **GSM Signal Strength Test**, **Monitoring Station Test**, and more (see *Testing the System*, page 227, and the respective sections in this manual).

Service Mode silences all tamper alarms at the main panel and peripheral devices/accessories for the duration of time required for device battery replacement.



Event Logging

The LightSYS Plus has the capability of storing up to 2000 events, including alarms, arming, disarming, bypassing, troubles, restores, and resets. These events are logged in order, according to date and time – and when applicable, according to zone, partition, area, user code, keypad, etc. Events are viewed on the keypad. Installers can also view events with the Configuration Software, and system users can also view events with the iRISCO Smartphone app and the Web user interface.

Programmable Outputs

The system has 4 programmable outputs on the main panel PCB, but the number of outputs is expandable up to 196. Outputs are for operating external devices in response to activities related to alarms, zones, partitions, system events, user actions, and scheduled events. Operation of outputs can be automated to operate according to a pre-defined schedule.

False Alarm Reduction Features

Features to help reduce false alarms include:

- Zone crossing
- Swinger limit (swinger shutdown) programmable by zone
- Audible exit/entry delay & exit restart
- Audible exit fault
- Soak test by zone
- Pulse count by zone
- Transmission delay
- Arm/disarm bell squawk
- Double verification of fire alarms
- Sequential alarm confirmation

Home Automation

LightSYS Plus supports RISCO's Cloud-based Home Automation services.

Safety Warnings and Precautions

 **WARNING:** Installation or usage of this product that is not in accordance with the intended use and manufacturer instructions can result in damage, injury or death. The system is NOT meant to be installed or serviced by those other than professional security alarm system installers.

 **WARNING:** Make sure this product is not accessible by those for whom operation of the system is not intended, such as children.

 **WARNING:** The main panel should be connected to an easily-accessible wall outlet so that power can be disconnected immediately in case of malfunction or hazard. If it is permanently connected to an electrical power supply, then the connection should include an easily-accessible disconnection device, such as a circuit breaker.

 **WARNING:** Coming into contact with 230 VAC can result in death. If the main panel is open while it is connected to the electrical power supply, do not touch any AC electrical wiring to/from the mains fuse terminals nor the mains fuse terminals.

 **WARNING:** Ensure proper grounding requirements are implemented for the system and peripherals, where required.

 **WARNING:** Replace battery with correct type to avoid the risk of explosion.

 **CAUTION:** Dispose of batteries according to applicable law and regulation.

Installation

Main Tasks for Initial System Setup

Installing and setting up the system should be performed by a professional alarm system installer. Presented here is a typical order of performing these tasks:

System Installation

Step 1: Creating a Plan for Mounting the System

Step 2: Wiring, Settings, and Module Installations at the Main Panel

Step 3: Bus Line Installations

Step 4: Connecting Relay Detectors

Step 5: Connecting the Backup Battery and Mounting the Main Panel

System Initialization, Device Allocation & General Configuration

Step 1: Describing Keypad Controls and Installer Menus

Step 2: Powering-Up and Initializing the System

Step 3: Allocating and Configuring Installed Components

Step 4: Allocating Wireless Zones

Step 5: Basic Zone Configuration for All Zone Types

Step 6: Advanced Zone Configuration for Bus Zones and Wireless Zones

Step 7: Configuring System Communication

Step 8: Configuring Cloud Connectivity

Step 9: Configuring Common System Parameters

Installer Programming

- Defining Parameters – Installer Programming Menu
- Exiting Installer Programming Menu after Initial System Programming
- Defining Parameters – Additional Installer Menus

System Testing

Various system tests are available for the LightSYS Plus. Relevant tests should be performed for verifying system operability during initial system setup, as well as after completion of the initial system setup (before system handover to the client). Tests are also available for system diagnostics. See *Testing the System*, page 227.

Installer Responsibilities in Assisting the Client

Upon handing over a fully configured and fully tested system to the client, a checklist is provided listing some of the main areas that the installer should assist the client with. See *Installer Responsibilities for Assisting the Client*, page 228.

Step 1: Creating a Plan for Mounting the System

Before you mount the main panel and peripheral system components, make a plan for obtaining the most optimal location. Depending on the configuration requirements, the main panel should typically be:

- Centrally located for minimizing lengthy bus line/expansion module wire runs
- In a location with good GSM reception
- In a secure location that is hidden and not reachable by those for whom use is unintended (such as small children)
- Near an uninterrupted 230 VAC electrical outlet, an easily-accessible disconnection device such as a circuit breaker (if permanently connected to the electrical power supply), grounding connection, and network cable outlet, as needed
- In a dry place, away from sources of disturbance (including electrical, RF and heat), and not near large metal objects which may hinder reception

Main Panel Mounting Considerations – Wireless Systems

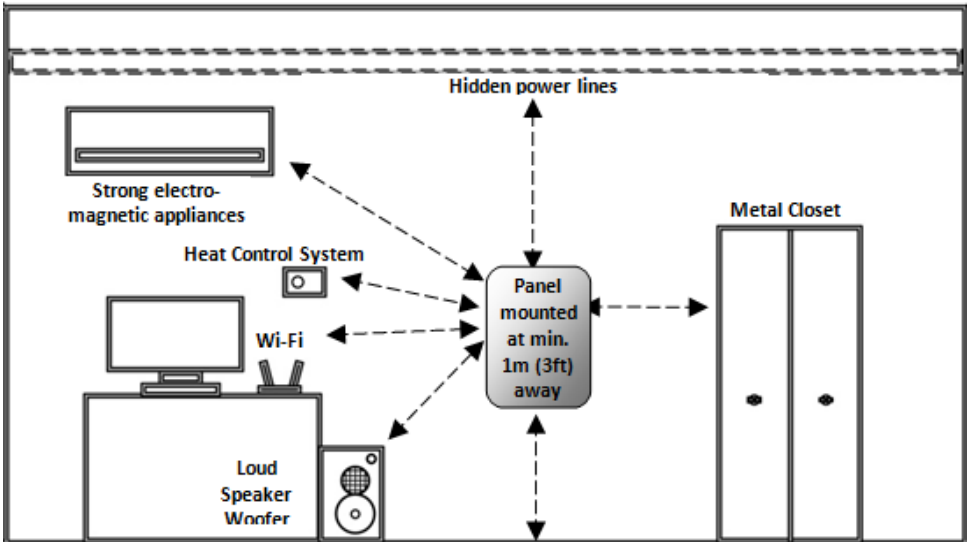

RF Signal Loss Due to Common Building Materials

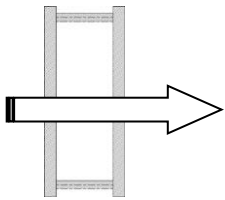
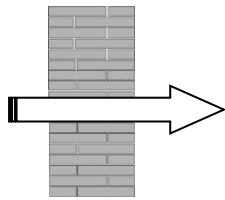
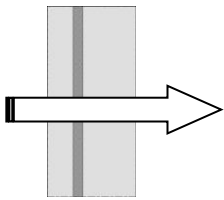
 <p>Wallboard and wood</p> <p>0%—10% loss of signal</p>	 <p>Light concrete or brick</p> <p>5%—35% loss of signal</p>	 <p>Heavy concrete and steel reinforcement</p> <p>70%—90% loss of signal</p>
---	--	---

Central Mounting Location – Wireless Systems

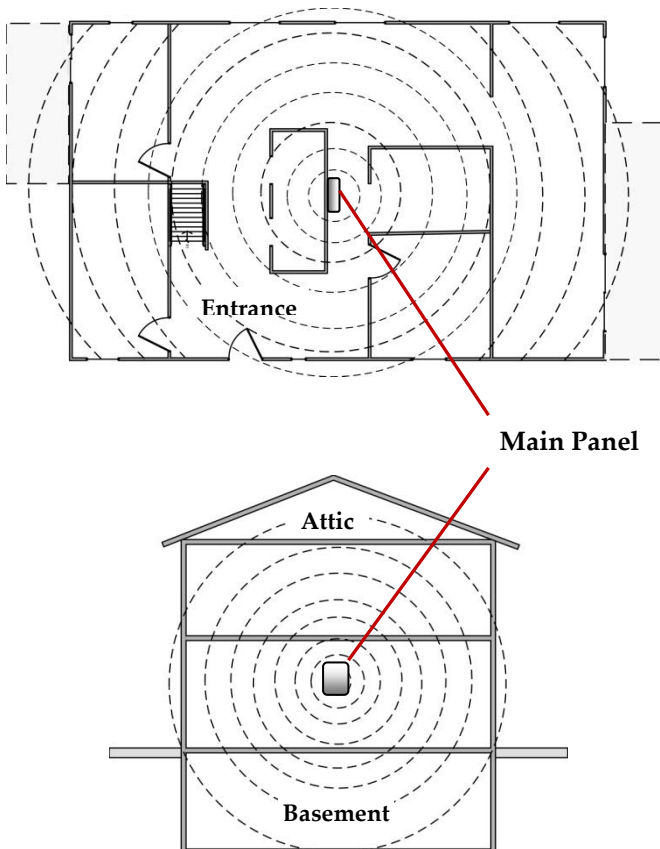

Step 2: Wiring, Settings, and Module Installations at the Main Panel

NOTE: Not applicable to Australia and New Zealand.

IMPORTANT:

- Electrical AC wiring should be performed by a certified electrician, and in compliance with applicable electrical code, laws and regulation. Refer to the box/enclosure instructions.
- The main panel should be connected to an easily-accessible wall outlet so that electrical power can be disconnected immediately in case of malfunction or hazard. If it is permanently connected to an electrical power supply, then the connection should include an easily-accessible disconnection device, such as a circuit breaker.

WARNINGS:

- To prevent risk of electric shock, **DO NOT** apply electrical power to the main panel nor connect the main panel's backup battery at any time during installation or servicing. The panel is not to be powered up until system initialization (see *Step 2: Powering-Up and Initializing the System, page 51*).
- To prevent damaging the system, replace fuses only with fuses of the same type and rating (**250V, 3.15A**).
- To prevent damage, injury or death, under no circumstances should a mains power cable be connected to the main panel/PCB other than to the mains fuse terminal block.

Power Supply, Ground

NOTE: The electrical power rating is specified on the label located next to the fuse.

➤ To wire the power supply and ground wiring:

1. **Do not connect AC power** at this point of the installation.
2. Refer to the box/enclosure instructions.
3. The system is powered by an AC/DC adaptor (100-240V, 50/60Hz, 14.4V – 2.5A/4.5A) that is pre-installed inside the main panel enclosure. Connection to AC must be permanent and connect through the mains-fuse terminal block as follows:

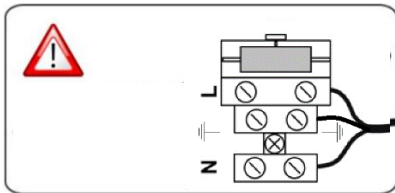

IMPORTANT: Clamp power cable wires to the box/enclosure housing using plastic ties, and thread them through the arched tie-down brackets on the base of the box/enclosure housing (see box/enclosure instructions).

IMPORTANT: For safety reasons use the fire enclosure, see the *LightSYS Plus Plastic Box Installation Instructions*

Main Panel Wiring Diagram

LightSYS Plus Wiring Diagram

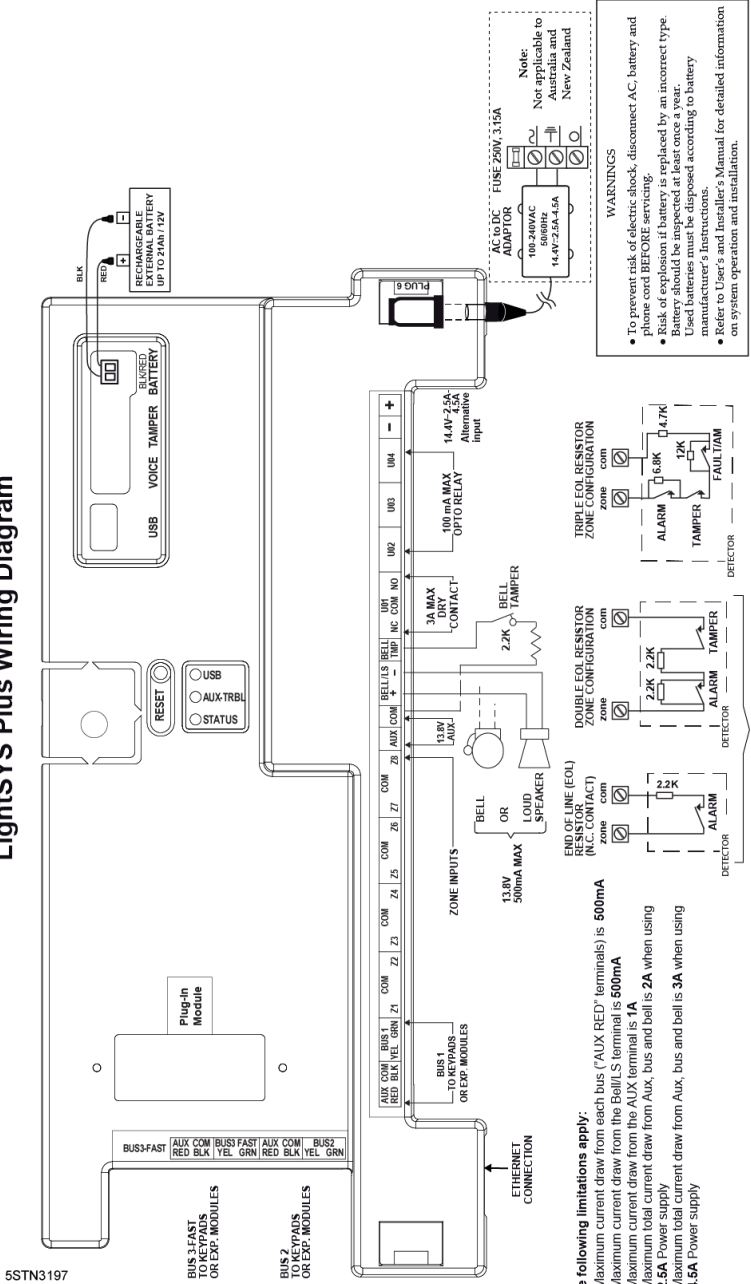

- The following limitations apply:**
1. Maximum current draw from each bus ("AUX RED" terminals) is **600mA**
 2. Maximum current draw from the BELL/S terminal is **600mA**
 3. Maximum current draw from the AUX terminal is **1A**
 4. Maximum total current draw from Aux, bus and bell is **2A** when using **2.5A** Power supply
 5. Maximum total current draw from Aux, bus and bell is **3A** when using **4.5A** Power supply



Replacing the Main Panel PCB

If replacing the main panel PCB, in order to prevent bus sirens from sounding, before you power-off the main panel first enter the installer Programming mode. Then you can power-off the main panel and replace the PCB assembly.

Main Panel Initial Settings

Settings	Operation	Status
1: Bell	From the installer Programming menu, go to: 1 > 5 > 1 > 2 (System > Settings > Siren Mode > Bell), and then press OK (✓).	YES: Bell: For a bell or electronic siren with a built-in siren driver. NO: For a loudspeaker without a built-in sound driver.
2: Default	<ol style="list-style-type: none"> 1. Using the HandyApp, scan the control panel's ID and note the unique 8-digit reset key that will display. 2. Reset the control panel. 3. From the keypad, press  + 8 simultaneously: <Enter reset key:> will display. 4. Enter the reset key and press OK (✓). <p>NOTE: The reset key should be entered within 5 minutes of panel reset.</p>	Intended for installer programming at initial system setup (from the installer Programming menu), this setting allows the installer to set the installer, sub-installer and Grand Master codes.
3: Bell tamper bypass	From the installer Programming menu, go to: 1 > 5 > 8 > 1 (System > Settings > Bypass Tamper > Bell tamper), and then press OK (✓).	YES: Bell tamper protection is bypassed (not active) NO: Bell tamper protection is not bypassed (active)
4: Box tamper bypass	From the installer Programming menu, go to: 1 > 5 > 8 > 2 (System > Settings > Bypass Tamper > Box tamper), and then press OK (✓).	YES: Box tamper protection is bypassed (not active) NO: Box tamper protection is not bypassed (active)

Describing Connectors & Ports on the Main Panel PCB

Connector/Port	Description
BUS 1 BUS 2 BUS 3	Bus “quick connectors” - a dedicated 4-pin serial connector for BUS Line 1. It may be used (depending on the device) instead of performing standard bus line wiring at the terminal block.
BOX TMP	Box/enclosure tamper
GSM CARD	GSM module
VOICE	For connecting to the Voice Module (use supplied 3-pin serial cable)
USB	USB port to connect to the Configuration Software computer/laptop (USB-C to USB-A cable required, not supplied)
DC JACK	For the RISCO-supplied and certified AC – DC adaptor. NOTE: Alternatively input DC can also be wired at the (-) and (+) terminals on the terminal block (next to DC JACK).
BATTERY	For connecting to the main panel backup battery (not-supplied)

RESET Button

Using a pin, press the RESET button for 10 seconds to restart the main unit.



Installing Plug-In Communication and Audio Modules

See the installation instructions included with each module for installation details, and see *Main Panel Wiring Diagram, page 28*.

⚠ CAUTION: Before installing any communication or audio module, in order to prevent damage to system components, make sure the main panel is **NOT** powered up, and that the panel’s backup battery is **DISCONNECTED**.

Installing a GSM Module

GSM modules provide voice and data communication over a cellular network. The G2, G3 and G4 GSM modules provide generation 2, 3 and 4 GSM communication.

➤ To install a GSM module:

1. Ensure the main panel is powered off.
2. Install the GSM module according to the installation instructions packaged with the module, as well as the *Main Panel Wiring Diagram, page 28* for the module’s connection location on the main panel PCB.

3. Ensure the antenna is attached onto its connector on the GSM module, and then slide the antenna into place on the box/enclosure housing according to the instructions packaged with the specific box/enclosure being used.
4. Insert the dedicated SIM card and, if required, enter its enabling PIN. You can disable the SIM PIN in advance by placing it in a cell phone and then disabling it, or you can disable it later during installer programming (where you can enter or disable the PIN) and also manually define the APN, if needed (see *Defining APN Automatically and Manually*, page 56).

IMPORTANT:

- Ensure that you remember the PIN for the SIM card. If you forget it and the SIM is locked, you may need to contact your cellular provider to unlock it.
- Do not install SIM card while power is applied to the LightSYS Plus.
- Do not touch SIM card connectors/circuitry. Doing so may release an electrical discharge that could damage the SIM card.
- Once the SIM card is installed, it is recommended to test the operation of the SIM by conducting a call and testing the GSM signal strength.

Connecting to IP

IP provide data communication over TCP/IP.

Connect the incoming LAN cable to its jack on the IP module, and ensure network connectivity.

Connecting to Wi-Fi

➤ **To Connect to Wi-Fi**

Note: Your Router's Wi-Fi must be activated for the Control Panel to recognize and communicate with the Router.

1. To connect via Wi-Fi network, you must select your Router's Wi-Fi network.
2. Go to Activities → Wi-Fi screen: available networks appear in a list.
3. Select the desired network and enter the password (if required).

Installing an LRT Module

A Long-Range (Radio) Transmitter module (LRT) can be installed on a bus line.

➤ **To install an LRT module:**

1. Ensure the main panel is powered off.
2. Install the LRT module on a RISCO bus and configure it according to the manufacturer's installation instructions.

Installing the Voice Module

Installed inside the main panel box/enclosure and connected to the main panel PCB, the Voice module provides audible system status. The Voice Module requires a GSM (G2, G3 or G4) module installed.

Upon a system event (such as an alarm activation), the Voice module calls the user and plays a pre-recorded event announcement. Using the telephone, the user first acknowledges receipt of notification, and then operates the system.

Optionally, the Voice module can be used for "listen-and-talk" communication between the user at the protected site, and the monitoring station. This requires the Listen-In & Speak Unit installed (see *Installing the Listen-In & Speak Unit*, page 34).

➤ To install the Voice Module:

1. Ensure the main panel is powered off.
2. Install the Voice module inside the main panel box / enclosure. Install and configure it according to the installation instructions packaged with the module. Also see the *Main Panel Wiring Diagram*, page 28 for the module's connection location on the main panel PCB.
3. Connect the Voice module to the main panel using the supplied cable (connect from the Voice connector on the Voice module to the Voice connector on the main panel):

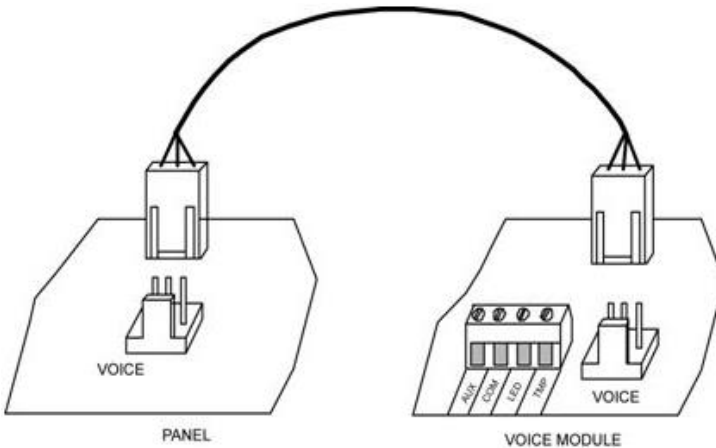

Installing the Listen-In & Speak Unit

Wired directly onto the Voice module, the Listen-In & Speak unit is a remote, external audio accessory that provides 2-way “listen-in-and-talk” communication between users at the premises and the monitoring station – for times of emergency. Multiple Listen-In & Speak units can be used in the system.

➤ To install the Listen-In & Speak unit:

1. Ensure the main panel is powered off.
2. Install the Listen-In & Speak unit according to its packaged installation instructions, and also the Voice module’s packaged installation instructions. Install Listen-In & Speak unit(s) where best utilized at the premises.

Wiring other Devices at the Terminal Block

Connecting a Wired Keypad

A wired keypad should be installed first, as it is used to set defaults upon system initialization (language, time and date), to perform an Auto-Setting scan for allocating all bus-connected devices, and configure parameters. Wired keypads can be connected directly at the main panel terminal block, or onto a RISCO bus line. See *Step 3: Bus Line Installations, page 37*.

Connecting Auxiliary (12 V DC) Devices

Use the **Auxiliary Power AUX (+) and COM (–)** terminals to power, for example, PIRs, glass-break detectors (4-wire types), smoke detectors, audio switches, photoelectric systems, or any device that requires a 12 V DC power supply.

NOTES:

- Maximum current draw for each bus (“AUX RED” terminals) is 500 mA.
- Maximum current from the AUX terminal is 1A.
- Total current draw from the panel terminal blocks should not exceed 2000mA, in addition to above limitations.
- If, at the main panel terminal block, any Bus or AUX outputs are overloaded and are shut down, you must disconnect all loads from those Bus or AUX outputs for a period of at least 10 seconds before you reconnect any load to those outputs.
- To increase your power ability when employing multiple auxiliary devices, you can use an optional Power Supply expansion module(s).
- For 4-wire smoke detectors, see the packaged installation instructions.

- To prevent a possible drop in voltage due to current requirements and distances involved, make sure to use the appropriate wire gauge (refer to the table of gauge sizes for AUX devices). See *Appendix B: Wiring*, page 231.

Connecting the Bell / Loudspeaker

The Bell & LS (loudspeaker) terminals provide power to the internal bell (siren).

NOTE: A maximum of 500 mA may be drawn from this output.

➤ To connect the internal bell (siren):

With main panel power removed, connect the internal bell with the correct polarity (for installation instructions see the packaged installation instructions).

Connecting the Bell Tamper

➤ To utilize the bell tamper:

- With main panel power removed, connect the bell tamper to the **BELL TMP** and **COM** terminals on the main panel using a 2.2K Ω resistor in serial.

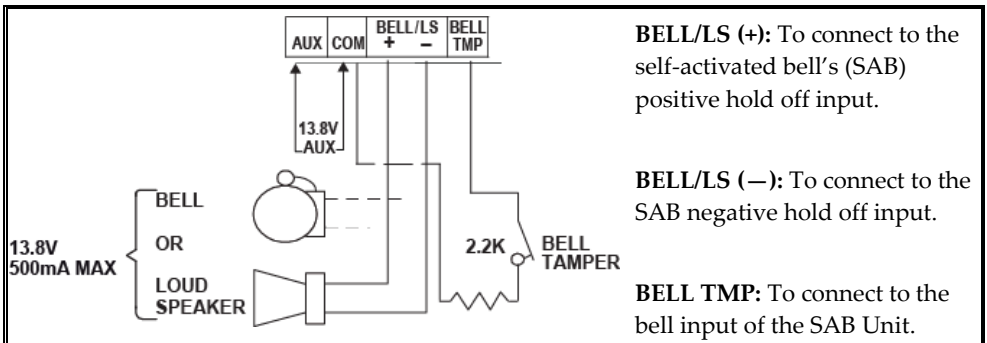

Connecting the Box Tamper (Wall Tamper)

The box tamper is pre-installed on the main panel housing (see box/enclosure instructions).

➤ To utilize the box tamper:

Connect back tamper wires to the **BOX TMP** terminals on the terminal block, or alternatively, connect via cable to the **BOX TMP** connection jack on the PCB.

NOTE: Do not wire the box tamper to both the terminal block and the PCB connector simultaneously.

Connecting 4-Wire Smoke Detectors

LightSYS Plus supports 4-wire smoke detectors. Refer to the detector’s packaged installation instructions.

- To connect a 4-wire smoke detector or device that requires resetting after an alarm condition, connect the auxiliary power AUX and output terminals. Use a power supervision relay to supervise the 4-wire smoke detectors. Loss of power to the detector(s) de-energizes the relay, causing a break in the zone wiring and a “Fire Fault” message at the panel. Remember to define the output as Switched Auxiliary.
- In addition, when connecting a 4-wire smoke detector, observe the wiring guidelines mentioned in the previous sections, along with any local requirements applicable to smoke detectors, as per the following diagram:

TYPICAL FIRE ZONE WIRINGS
(TWO 4 WIRE SMOKE
DETECTIONS)

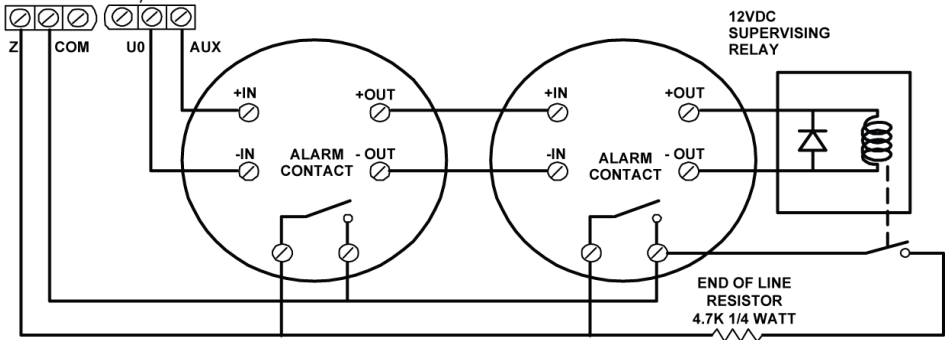

Step 3: Bus Line Installations

LightSYS Plus supports up to 3 separate, independent RISCO bus lines. If one bus line ever experiences a problem that interrupts data flow (such as being cut or shorted), the other RISCO bus lines will continue operating normally.

Bus Line Wiring

On the main panel PCB, the 4 wires of each RISCO bus line (red, black, yellow, green) connect to the respective screw terminals on the terminal block as follows:

Bus screw terminal	Purpose
AUX RED	+12 V DC power
COM BLK	0V common
BUS YEL	Data (yellow wire)
BUS GRN	Data (green wire)

Describing Bus Devices

All peripheral devices (bus detectors, keypads, sirens) as well as expansion modules (8-Zone Expanders, Single-Zone Expanders, Wireless Expanders, Power Supply Expanders, Bus Zone Expanders, Output Expanders) that **connect and communicate to the main panel via bus line** are all referred to as bus-connected devices, or “bus devices.” Bus devices fall under **categories** pertaining to zones, outputs, power supplies, wired keypads and sirens.

NOTE: Even though zone expanders (single-zone and 8-zone) connect relay detectors and not bus detectors, they are bus devices.

Describing Bus Detectors and their Connection Options

Connect multiple bus detectors to RISCO bus lines via Bus Zone Expanders (BZEs), which serve to expand the number of bus detectors and also enhance bus security and performance. A smaller number of bus detectors can be connected individually without connecting to Bus Zone Expanders – they are wired to a bus at the main panel PCB. For installation, refer to the instructions supplied with the bus detector.

Typical Wired Expansion Modules Installed on RISCO Bus Lines

The following shows different types of wired expansion modules typically installed on a RISCO bus line (all are bus devices). Note that wireless expanders can also be wired to a RISCO bus line.

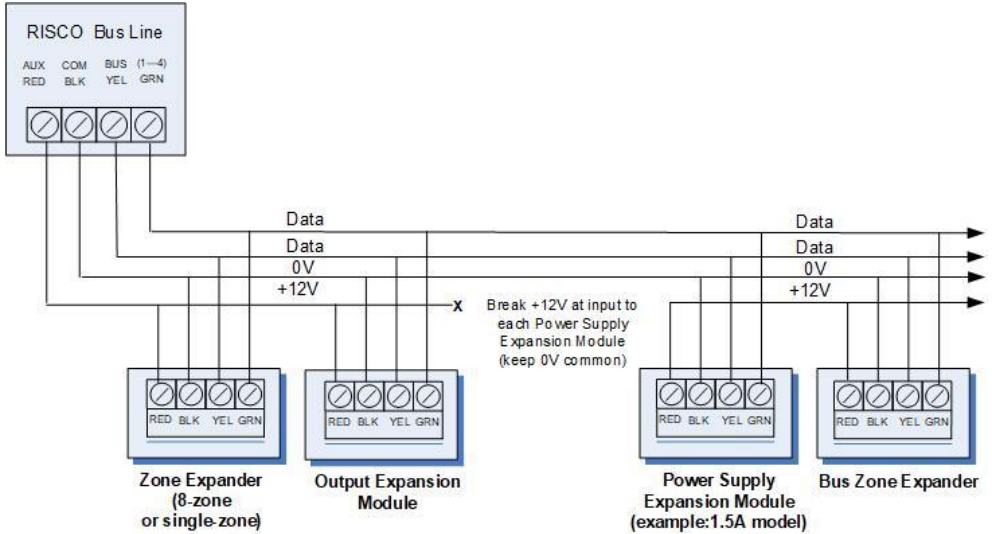

NOTES:

- The parallel wiring system supports parallel connections from any point along the wiring.
- For maximum system stability, it is best not to exceed a wire run of 300 meters (1000 feet) for each leg of a bus line. For a distance of more than 300 meters, contact RISCO Customer Support.
- In case of bus communication problems, connect two of the supplied 2.2K Ω resistors, with one at each end of the bus data terminals (connecting the green to the yellow terminals).
- For long cable runs, please use the correct cable / gauge sizes as stated in the *Appendix B: Wiring, page 231*.
- If connecting remote power supply units, **do not** connect the red wire (+12 V) between the power supply unit and the LightSYS Plus main panel. Break the +12V at the input to each power supply expansion module (keep 0V common).
- If additional current is required on a bus line, install power supply expansion module(s).

Describing Installer-Set ID Numbers for Bus Devices

For each bus device category (see the table below), each of its respective bus devices gets a sequentially-assigned, installer-set “physical” ID number that the installer physically sets with the device’s DIP switches before powering up the device.

NOTE: To be unique, bus devices in the same category that are on the same bus line must have sequentially different physical ID numbers, whereas different devices (or the same bus device types on different bus lines) can have the same physical ID number.

Categories	Respective Bus Devices
ZONES	Bus Zone Expanders
	Bus zones (bus detectors)
	Zone expansion modules: single-zone expander, 8-zone expander
	Wireless expander
OUTPUTS	Output expansion modules: 4 outputs/3A, 8 outputs/100 mA
POWER SUPPLY UNITS	Power supply expansion modules: 3A
WIRED KEYPADS	Elegant, LCD, etc.
BUS SOUNDERS	ProSound, Lumin8
KEY READERS	Proximity Key Reader

ID Number Formats

Keypads, sirens, as well as expansion modules (bus zone expanders, zone expanders, wireless expansion modules, utility output modules, power-supply expansion modules) that are connected via a RISCO bus line display on the keypad as per this example: **02(1:01) T=NZE08**

EXPLANATION:

- **02** is the index number of keypad, siren, or voice/expansion module
- **1** is the RISCO bus line number that it is on
- **01** is the sequential, installer-set physical ID number
- **T** (type) is NZE08 (8-zone expander)

System detectors and accessories (other than keypads, sirens and expansion modules) have their zones display as per these examples:

- **Bus detector** connected via a Bus Zone Expander: **3:B08:05**
- **Relay detector** wired to a zone expander: **3:E08:05**, or wired to a zone (1–8) on the terminal block: **3:E00:05**
- **Input zone** (relay detector that is wired directly onto a compatible type of bus device (such as the iWISE Bus and Elegant keypad), which thereby shares its bus line connection): **3:I08:05**
- **Wireless detector** connected to a wireless expansion module: **3:W08:05**

EXPLANATION (for all 4 examples above):

- **3** is the RISCO bus line number
- The next value (**B08**, **W08**, **E08**, or **I08**) is for the ID of the expansion module or input zone that the detector is connected to (B = bus zone expander, W = wireless zone expander, I = input zone, E = wired zone expander)
- **05** is the sequential, installer-set physical ID number

NOTES: [For main panel terminal block wiring]:

- For a bus zone expander wired to a bus line at the terminal block, its ID will show as **B00**.
- For a relay detector wired to a zone (1–8) at the terminal block, its ID will show as **E00**.
- For a UO module wired to a UO terminal at the terminal block, its ID will show as **0x** (whereas x= zone number 1–6).

Assigning ID Numbers (Setting DIP Switches) for Bus Devices

When installing each bus device, you must set its DIP switches to match its sequentially-assigned physical ID number **before the device is powered up**.

NOTE: If after power-up a device's DIP switch(s) are changed, it will be necessary to shut down the device's power and then power it up again.

➤ **To set a bus device's ID with its DIP switches:**

- For each bus device, set its physical ID number by placing its DIP switches to ON or OFF according to the table. Bus devices have between 3 and 5 DIP switches (check the device's packaged instructions for details, as some devices may have DIP switch(s) that are not to be used for setting the device ID).

NOTE: Categories of bus devices with 3 DIP switches can be comprised of up to 8 IDs, those with 4 DIP switches up to 16 IDs, and those with 5 DIP switches up to 32 IDs. See the following examples and the table:

EXAMPLE: For a bus device with 3 DIP switches, to assign ID 02, DIP switch 1 needs to be set to ON, and DIP switches 2 and 3 need to be set to OFF.

EXAMPLE: For a bus device with 4 DIP switches, to assign ID 04, DIP switches 1 and 2 need to be set to ON, and switches 3 and 4 need to be OFF.

EXAMPLE: For a bus device with 5 DIP switches, to assign ID 07, DIP switch 1 needs to be set to OFF, DIP switches 2 and 3 need to be ON, and DIP switches 4 and 5 need to be OFF.

Bus device ID	DIP switches				
	1	2	3	4	5
01	OFF	OFF	OFF	OFF	OFF
02	ON	OFF	OFF	OFF	OFF
03	OFF	ON	OFF	OFF	OFF
04	ON	ON	OFF	OFF	OFF
05	OFF	OFF	ON	OFF	OFF
06	ON	OFF	ON	OFF	OFF
07	OFF	ON	ON	OFF	OFF
08	ON	ON	ON	OFF	OFF
09	OFF	OFF	OFF	ON	OFF
10	ON	OFF	OFF	ON	OFF
11	OFF	ON	OFF	ON	OFF
12	ON	ON	OFF	ON	OFF
13	OFF	OFF	ON	ON	OFF
14	ON	OFF	ON	ON	OFF
15	OFF	ON	ON	ON	OFF
16	ON	ON	ON	ON	OFF
17	OFF	OFF	OFF	OFF	ON
18	ON	OFF	OFF	OFF	ON
19	OFF	ON	OFF	OFF	ON
20	ON	ON	OFF	OFF	ON
21	OFF	OFF	ON	OFF	ON
22	ON	OFF	ON	OFF	ON
23	OFF	ON	ON	OFF	ON
24	ON	ON	ON	OFF	ON
25	OFF	OFF	OFF	ON	ON
26	ON	OFF	OFF	ON	ON
27	OFF	ON	OFF	ON	ON
28	ON	ON	OFF	ON	ON
29	OFF	OFF	ON	ON	ON
30	ON	OFF	ON	ON	ON
31	OFF	ON	ON	ON	ON
32	ON	ON	ON	ON	ON

Installing Bus Devices

When installing bus devices, in addition to the information presented in this manual, always refer to the device's packaged installation instructions.

Installing Wired Keypads

Connected either to a RISCO bus line, or to a bus at the terminal block on the main panel PCB, a wired keypad is the first system component to be installed, as it is used to set the initialization defaults upon system power-up (language, time and date) and view total zone information. It is then used to perform an Auto-Setting scan for purposes of identifying, then allocating and configuring all installed communication modules and bus devices.

➤ To install a wired keypad

1. Ensure the main panel is powered off
2. Set the keypad's DIP switches (see *Describing Installer-Set ID Numbers for Bus Devices*, page 39), and in accordance with the keypad's packaged instructions.
3. Set the keypad's back tamper switch per keypad instructions.
4. Wire the keypad to a RISCO bus line, or to a bus on at the main panel terminal block (see *Main Panel Wiring Diagram*, page 28).
5. Refer to the keypad instructions for additional installation information.

Installing Bus Detectors

Connecting Individual Bus Detectors to a Bus at the Main Panel

➤ To connect bus detectors individually on a bus at the main panel PCB:

1. Remove system power.
2. Connect each bus detector to the bus line per its packaged instructions.
3. Sequentially assign each bus detector's ID (01 – 32) and set accordingly with its 5 DIP switches. See *Assigning ID Numbers (Setting DIP Switches) for Bus Devices*, page 37.

NOTE: For WatchOUT, LuNAR, WatchIN, BWare and Seismic set the switch that defines the detector's operational mode to "bus mode."

4. Connect the 4 bus wires to their respective bus screw terminals on the main panel PCB (terminal block): AUX (RED), COM (BLK), BUS (YEL), BUS (GRN).

NOTE: For maximum operation stability, it is best that the bus line wiring from any bus detector to the main panel should not exceed a total 300 meters (1000 feet). For a distance of more than 300 meters, contact RISCO Customer Support.

NOTE: For testing the bus, see *Performing a Bus Test*, page 54.

Installing Bus Zone Expanders

The Bus Zone Expander (BZE) serves to expand the number of bus devices used in the system. It also acts as a bus isolator for increasing bus security, and as a bus detector concentrator for improving bus performance.

- To install a Bus Zone Expander, refer to the packaged installation instructions.

Connecting Multiple Bus Detectors using Bus Zone Expanders

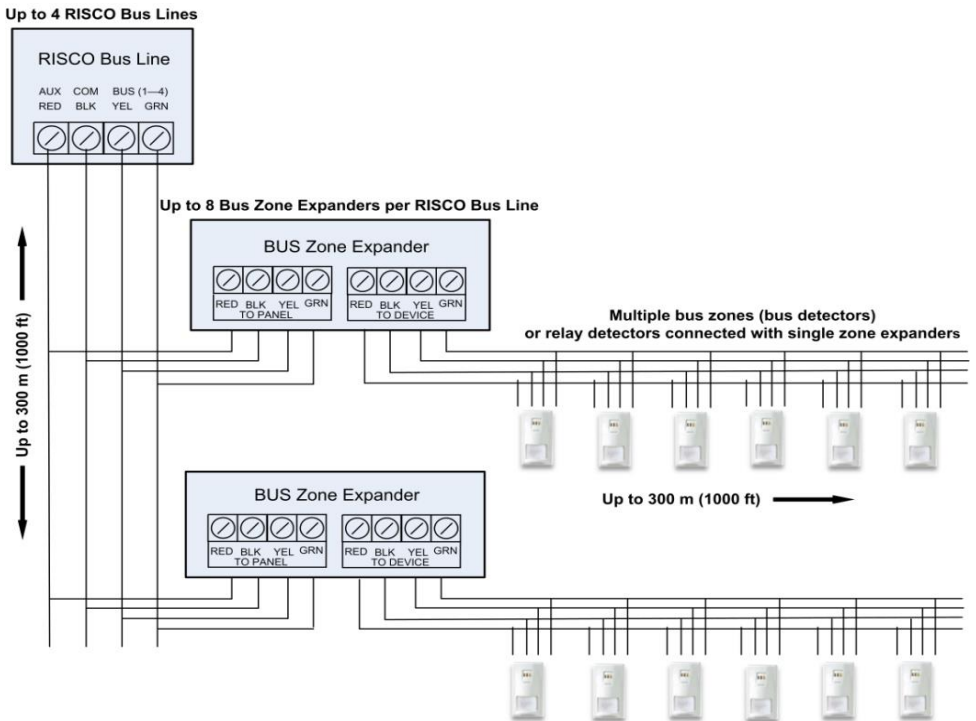

- **To connect multiple bus detectors to bus lines using Bus Zone Expander(s):**
1. Remove system power.
 2. At SW1 on the BZE (Bus Zone Expander), use DIP switches 1—3 to sequentially set the BZE's physical ID number. Note that DIP switch 4 is not used.
 3. At SW2 on the BZE set DIP switch 3 to **ON**.
 4. At SW2 on the BZE, set DIP switch 4 to **OFF** to utilize the tamper switch, or set it to **ON** to disable the tamper.
 5. Wire the bus line to the BZE terminals marked **TO PANEL**.
 6. Set each bus detector's physical ID number sequentially, using each detector's DIP switches.
NOTE: Do not assign the same physical ID number to more than one detector on the same BZE.
 7. Wire each bus detector's terminals to the BZE terminals marked **TO DEVICE**.
NOTE: For maximum operation stability, it is recommended not to exceed 300 meters (1000 feet) of wiring from any BZE to the main panel, and not to exceed 300 meters (1000 feet) of wiring from any BZE to the farthest detector it supports. For a distance greater than 300 meters (1000 feet) contact RISCO Customer Support.
NOTE: For testing the bus, see *Performing a Bus Test*, page 54.

Installing Power Supply Expansion Modules

The LightSYS Plus supports the addition of a multiple supervised / switching power supply expansion module (3A model), that operates from AC power, connected to a bus, and serves to expand the total current capacity when needed. See *Appendix A: Technical Specification*, page 229 for specific information on the available models.

The 3A power supply expansion module has advanced remote diagnostics (including remote upload/download or keypad reading of voltage output and current under load) and supports a standby battery and a 1.7 A siren. It is self-supervised for loss of mains power, battery power, failure of its auxiliary output power, and loss of sounder loop integrity (sounder device).

The 3A power supply expansion module also supports two utility outputs.

- To install power supply expansion module(s), refer to their packaged installation instructions

Installing Utility Output Expansion Modules

The LightSYS Plus supports the following programmable UO (Utility Output) expansion modules, whose outputs may be activated as a result of numerous events related to system, partition, zone, or user:

4 x 3A Relay Output Expander

8 x 100 mA Open-Collector Output Expander

- To install UO expansion module(s), refer to their packaged installation instructions

Installing Wireless Expanders

A Wireless Expander module can be installed in the box/enclosure housing, as well as on RISCO bus lines.

NOTE: When adding a wireless expander, define the wireless expander's "Bypass Box Tamper" as **YES** if the wireless expander is mounted inside the LightSYS Plus box / enclosure housing and not in its own.

- To install Wireless Expander modules, refer to the packaged installation instructions.

Installing Bus Sounders (Sirens)

LightSYS Plus is compatible for bus sounders, such as the **ProSound** and **Lumin8**.

- To install bus sounders, refer to their packaged installation instructions

Step 4: Connecting Relay Detectors

Wired non-bus detectors (“relay detectors”) can be connected to the system the following ways:

- Connect relay detector(s) directly at the zone input terminals (Z1—Z8) on the terminal block of the main panel PCB. See *Main Panel Wiring Diagram, page 28*.
- Connect multiple relay detectors onto 8-Zone Expanders (see the illustration below)
- Connect relay detector(s) onto RISCO bus lines, each using a dedicated Single Zone Expander (see the illustration below)
- Connect a single relay detector directly onto bus devices which support an input zone. For the Elegant keypad, connect a relay detector to **ZONE IN** and **ZONE COM** terminals, and for the iWISE Bus detector connect to **Z1** and **COM** terminals.

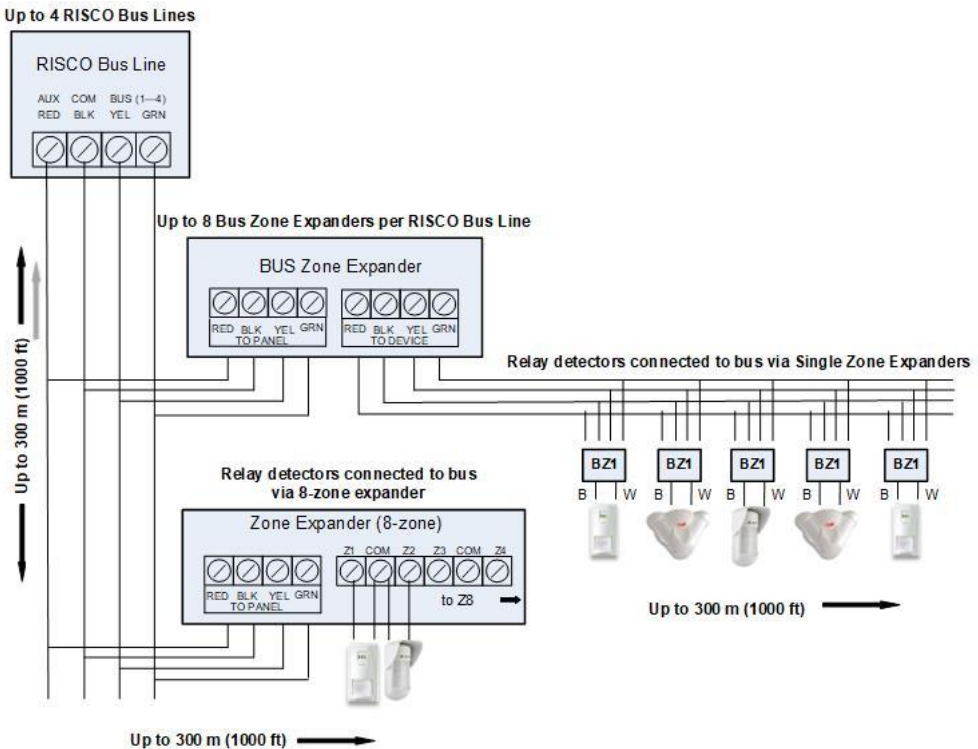

Installing Zone Expanders

8-Zone Expanders, and Single-Zone-Expanders all enable you to expand the number of wired zones --for example, non-bus (“relay”) detectors used in the system.

While a Single Zone Expander connects only one single relay detector to a bus line (each individual relay detector requires a dedicated Single Zone Expander), each 8-Zone Expander supports up to 8 relay detectors. See *Step 4: Connecting Relay Detectors*, page 46.

NOTE: When connecting Single Zone Expanders directly to a Bus Zone Expander, connect the Single Zone Expander’s bus wires (red, green, yellow, black) to the respective terminals on the Bus Zone Expander that are marked **TO DEVICE**

LightSYS Plus provides selectable, variable EOL (end-of-line) zone termination resistance options, compatible for RISCO relay detectors, as well as those of other manufacturers (for example, if performing a retrofit installation). Termination resistance is defined for each single-zone, 8-zone expander used in the system (as well as for each relay detector they support).

- To install zone expanders, refer to their packaged installation instructions.

Defining Zone Termination Resistance

A zone’s termination (end-of-line) resistance can be defined for relay detectors (not wireless or bus detectors), and it involves first physically wiring resistors (if not already in place) at installation, and then afterwards selecting the zone’s termination resistance option at the keypad during installer programming. See *Defining Zone Termination Resistance using the “Resistance” Option*, page 68.

NOTE: For relay detectors wired to zone expanders, during installer programming you separately define their individual termination resistance values and also define them for the zone expanders.

Wiring Resistors for Zone Termination Resistance

➤ To wire termination resistors:

- For RISCO EOL (end-of-line) and DEOL (double-end-of-line) detectors without built-in termination resistance, install a 2.2K Ω end-of-line resistor at the detector-side of each hard-wired zone
- For a detector with a tamper switch, you can use DEOL termination to save additional main panel connections
- For RISCO TEOL (triple-end-of-line) detectors without built-in EOL resistance, install 4.7K Ω , 6.8K Ω and 12K Ω resistors at the detector-side of each hard-wired zone. TEOL is supported to identify detector masking and trouble.

Zone Termination Configuration Options

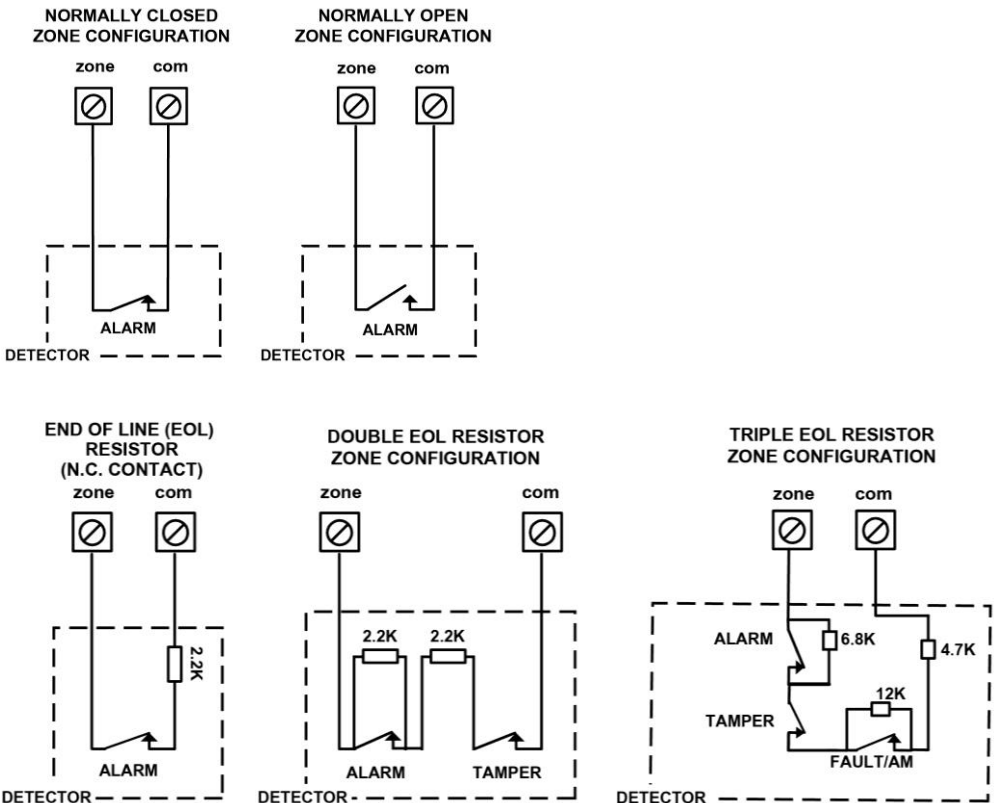

Step 5: Connecting the Backup Battery and Mounting the Main Panel

Install the backup battery and then mount the main panel on the wall.

Connecting the Backup Battery

The main panel's backup battery is not supplied with the system. You will need to install a **rechargeable battery (12 V, 21Ah)**, which is automatically utilized as a backup in case of power failure.

WARNINGS:

- To prevent damage, do not connect the backup battery until completion of all installation tasks, and until the system is ready for initial power-up.
- Install battery with the correct polarity.
- There is a risk of explosion if a battery is replaced with an incorrect type.
- Dispose of used batteries according to applicable law and regulation.
- The battery will take at least 24 hours before it can be fully used for backup.
- Replace backup battery about every 3–5 years. No maintenance is needed.
- The battery needs to be UL approved and have the UL94 V-1 casing, or better.

➤ To connect the backup battery:

1. Connect the leads of the battery cable to the respective (+) and (–) terminals on the battery and ensure correct polarity.
2. Insert the backup battery into its place in the main panel box/enclosure housing (see the instructions packaged with the box/enclosure).
3. Connect the battery cable onto the Battery connector on the main panel PCB.

Mounting the Main Panel

➤ To mount the main panel:

- Close up the box/enclosure and mount it to the wall (see the box/enclosure installation instructions) and see *Step 1: Creating a Plan for Mounting the System, page 24*. You are now ready for initial system power-up and initialization.

System Initialization, Device Allocations & General System Configuration

For installer programming using the Configuration Software, see its documentation.

Step 1: Describing Keypad Controls and Installer Menus

Describing Dynamic Keypad Menus

The LightSYS Plus installer menus are dynamic, in that they display menu items according to the devices connected in the system.

Table of Keypad Buttons



The following describes the typical Elegant/Panda keypad buttons used for programming:

NOTE: On other keypad the buttons may differ. See their packaged instructions.

Elegant Key	Panda Key	Description
1-0	1-0	For entering codes, using quick keys (to quickly access a menu option, labels, and for entering other numeric values).
		To go back a step in the menu, to exit a menu or return to the beginning of a menu.
i		Long-press to get system status
✓		Confirm (after entering) / OK / Save
		For scrolling through menus and menu options, and for toggling, such as between "ON" and "OFF" options.
		To toggle between options (such as Yes and No)
A, B, C, D	A, B, C, D	To select the corresponding group (A–D)

Designating Labels

The following table describes all the available characters at the Elegant/Panda keypad that can be used for labels (names/descriptions).

Key	Character Options	Key	Character Options
1	1 . , ' ? ! \ " - < > @ / : _ + * #	7	7 P Q R S
2	2 A B C	8	8 T U V
3	3 D E F	9	9 W X Y Z
4	4 G H I	0	0 (also use for blank space)
5	5 J K L	A	To toggle between lower case and capital letter
6	6 M N O		To scroll through all possible characters,
			to toggle through options (Yes/No)

Entering the Installer Programming Menu at Initial System Setup

After initial system power-up, language/time/date setting, viewing enabled zones and defining system partitions, you'll be in the installer Programming menu (at the Auto Settings bus scan).

IMPORTANT: After you finish initial system setup programming tasks from the installer Programming menu, you must exit the installer Programming menu (see *Exiting Installer Programming Menu after Initial System Programming*, page 217).

Step 2: Powering-Up and Initializing the System

When a new system is powered-up the first time, here are the initialization steps:

- 1: Initial power-up, language selection. The system automatically connects to the Cloud.
- 2: View enabled zones, define the maximum number of system partitions, and set the time & date.

System Power-Up and Language Selection

➤ To initially power-up and select a language:

1. Power-up the main panel; the keypad panel takes a few seconds to initialize (there may be an automatic 3-minute upgrade that runs automatically, during which the upgrade and power icons may display on the keypad – **make sure you do not disconnect**).
2. Press **Exit** when prompted, then scroll to select a language & press **OK** (✓).

NOTES:

- During regular system operation (after initial system power-up & settings) the language can be subsequently changed by pressing **Exit** () + 9 simultaneously.
- If powering up subsequently (after initial power-up and system initialization), language, time & date settings will not automatically appear. Instead, you will be prompted to enter the installer code to access the Installer menus for programming.

Defining Partitions

You can opt to define the maximum partitions at a later stage – from the keypad (during installer programming), or from the Configuration Software.

Keypad Timeout

When in installer Programming, if no entry is made to a keypad after the pre-defined time period (see installer Programming menu), it will beep and display TIME OUT, HIT ANY KEY. Press any key to stop the beeping, then re-enter your installer code to get back in the installer Programming menu.

Defining Partitions after Initialization

➤ To define the partition quantity after system initialization:

1. Go to: **1 → 5 → 7 (System → Settings → Partition Qty)**, and then press **OK (✓)**; **MAXIMUM PARTITIONS? 08 (08—32)** displays.
2. Enter the maximum number of partitions to enable in the system – the default is 08 (meaning up to 8), but up to 32 can be selected. If you want more than 8 partitions, enter the number.
3. Press **OK**.

Step 3: Allocating and Configuring Installed Components

Perform an Auto-Setting scan to locate, allocate, and configure all installed communication modules & bus devices.

NOTE: The automatic setting/un-setting function is not in compliance with EN50131-3.

Auto-Setting Scan for Communication Modules & Bus Devices

Performing an Auto-Setting scan finds all installed communication modules and bus devices connected in the system. As you view the results, you allocate (“enable”) each, and then you can configure their settings now, or later during installer programming. For configuration details see *Manually Allocating & Configuring Communication Modules on page 55*, and see *Manually Allocating & Configuring other Modules and Bus Devices on page 57*.

➤ To perform an Auto-Setting system scan:

1. Upon accessing the installer Programming mode after system initialization, when **BUS DEVICE: 1)AUTOMATIC** displays (Auto Settings feature), press **OK** (✓); **BUS SCANNING** displays while scanning, until the results display – first are the communication modules that were found, followed by the bus devices.
2. Press **OK** to enable the first communication module displayed and keep pressing **OK** to progress through its parameter configuration screens (which you can configure now or later during installer programming).
3. Press **OK** again to advance to the next communication module (if applicable) – followed by all other bus devices found and again enable/configure for each.
4. Make sure all the communication modules/bus devices found in the scan match all the communication modules/bus devices physically connected in the system. When **BUS Device: 1)Automatic** displays again and the panel beeps, it indicates you have finished the Auto-Setting scan.
5. Now you can perform a Bus Test to ensure good communication between the allocated bus devices and the main panel (see *Performing a Bus Test, page 54*).

NOTE: If you subsequently add more bus-connected devices, you can either allocate and configure them manually, or repeat the Auto-Setting system scan at:

Programming menu → 7) Install → 1)BUS Device → BUS Device: 1)Automatic

Describing Auto-Setting Results

At the keypad, the results of an Auto-Setting scan first show the connected communication modules. The next results displayed are for connected keypads, expansion/voice modules and bus detectors. Results display as per this example:

(3:02:01) T=LCD

EXPLANATION:

NOTE: Dashes (“—”) appear instead of digits when a parameter is not relevant, for example, for communication modules as they are on-board (on the PCB), and not on a bus line.

- 3 is the bus line it is connected to
- 02 is the expander ID
- 01 is its sequential, installer-set physical ID number for bus devices. Note that communication modules will always appear as 01.
- T is the type, which, in this example is an LCD keypad

Performing a Bus Test

A Bus Test checks each installed bus device and communication module to ensure adequate connectivity quality.

A result of 97% or less than may mean that there are bus connection problems.

➤ To perform a Bus Test:

1. From the **installer Programming menu**, go to: **7 → 1 → 3 → 1 (Install → Bus Device → Testing → Bus Test)**; BUS TEST displays for a few seconds until the “BUS COM QUALITY” results display.
2. Scroll to view the results for each bus device/module on the tested bus. If a result is not adequate, check physical connections and DIP switch positions, and then repeat the test. Results display as per this example: **GSM :001=100%**

EXPLANATION:

- **GSM** is the bus device/communication module description
- **001** is the bus device/communication module index number
- **100%** is the result

Manually Allocating & Configuring Communication Modules

If you didn't yet run an Auto-Setting scan to allocate ("enable") each installed communication module, you can do so manually from the installer Programming menu, as well as configure its relevant parameters.

IMPORTANT: If an allocated communication module is no longer to be utilized, you must disable it (cancel its prior allocation) via this manual process. After cancelling, if needed, you can then re-write over it to newly allocate another communication module.

NOTE: To set additional parameters, see *Installer Programming, page 79*.

NOTE: After manually programming communication modules, you can perform a bus test (see *Performing a Bus Test, page 54*).

GSM Modules

1. From the **installer Programming menu** select **7** → **1** → **2**, scroll to **10) GSM**, and then press **OK** (✓).
2. Toggle to the type of GSM module installed (or select **NONE** to cancel its allocation) and then press **OK**.

Entering or Deleting a SIM Card PIN

If your SIM card required a PIN (personal ID number) you will need to enter it. If not, you will need to disable it.

➤ To enter or delete a SIM card PIN:

1. From the **installer Programming menu** select **5** → **1** → **2** → **5** → **1**, enter the PIN, and then press **OK** (✓).

-OR-

2. If a PIN is not needed, you can choose to disable it by inserting the SIM card in a cell phone and disabling the code.
3. You can manually define APN definitions if you don't have them configured automatically (default), see *Defining APN Automatically and Manually, page 56*.

NOTE: It is recommended to test the operation of a SIM card by conducting a call and testing the GSM signal strength. See *Testing the System, page 227*.

Defining APN Automatically and Manually

After the SIM card is installed and upon establishing GSM/GPRS/3G/4G communication, the system's auto-APN feature will automatically configure the APN definitions. However, there may be cases where you will need to manually define the APN by entering the APN (Access Point Name) code supplied from the cellular provider, username, and password.

NOTE: If any of the APN definition fields are populated manually, the auto-APN feature will not operate.

➤ To manually set the APN definitions:

1. From the installer Programming menu, select: **5 → 1 → 2 → 2 → 1** (**Communication → Method → GSM → GPRS → APN code**), and then press **OK (✓)**.
2. Enter the **APN code** and then press **OK**.
3. Scroll to **2) APN User Name**, press **OK**, enter the **username** and then press **OK**.
4. Scroll to **3) APN Password**, press **OK**, enter the **password** and then press **OK**.

Setting Dynamic IP / Static IP

To set IP communication to Dynamic IP or Static IP, go to: **5 → 1 → 3 → 1 → 1**, scroll to either **1) Dynamic IP** or **2) Static IP**, and then press **OK (✓)**.

Long-Range Radio Transmitter Module

See the LRT instructions.

1. From the **installer Programming menu** select **7→1→ 2**, scroll to **12) LRT**, and then press **OK (✓)**.
2. Toggle to the type of LRT module installed (or select **NONE** to cancel its allocation), and then press **OK**.

Cellular On Bus (COB)

See the COB instructions.

1. From the **installer Programming menu** select **7→1→ 2**, scroll to **13) COB**, and then press **OK (✓)**.
2. Toggle to the type of COB module installed (or select **NONE** to cancel its allocation), and then press **OK**.

Manually Allocating and Configuring STU Adapter

For the UK only.

Manually Allocating & Configuring other Modules and Bus Devices

If you didn't yet run an Auto-Setting scan to allocate ("enable") all the installed non-communication modules (for example, expansion modules) or other bus devices – or if you are adding new ones and don't want to perform an Auto-Setting scan of the entire system, instead you can allocate them manually from the installer's Programming menu. Also, if you didn't configure the parameters during an Auto-Setting scan, you can do so now.

IMPORTANT: If no longer utilizing a previously allocated module/bus device, you'll need to manually cancel its allocation. After cancelling, if needed, you can then re-write over it (to newly allocate) another module/bus device.

NOTE: To set additional parameters, see *Installer Programming*, page 79.

NOTE: After manually programming other modules and bus devices, you can perform a Bus Test to ensure good communication between the bus devices and the main panel (see *Performing a Bus Test*, page 54).

Wired Keypads

1. From the **installer Programming menu**, select **7** → **1** → **2**, then scroll to **01)Keypad** and press **OK** (✓).
2. Scroll to, and then edit the keypad's physical ID number to match its DIP switch settings (see *Describing Installer-Set ID Numbers for Bus Devices*, page 39).
3. Toggle to the correct keypad type (or select **NONE** to cancel its allocation) and then press **OK**; Assign to Partition displays.
4. Scroll to manually edit (type in) the partition number or toggle to the correct partition number, and then press **OK**; the Mask screen displays where you enable operability of specific partition(s) with this keypad. By default, for keypad 01 all partitions are enabled.
5. While scrolling through each block of partitions, designate the partition(s) to allow operation via the keypad. Enter a partition number to select it (it will display) or enter the number again to clear it (it will not display). Then press **OK**; Controls / 1)Emergency displays.

6. Scroll to Control parameters and press  to enable/disable (Y/N) as needed:
 - **1)Emergency:** to operate the emergency quick keys at the keypad.
 - **2)Multi View:** to view from this keypad the status of all masked partitions (select Y) or only the partitions (select N).
7. Press **OK** to go to the next keypad and repeat this procedure from step 2.

Zone Expanders

1. From the **installer Programming menu**, select **7→1→2**, scroll to **02) Zone Expand** and then press **OK (✓)**.
2. Scroll to, and then edit the zone expander's physical ID number to match its DIP switch settings (see *Describing Installer-Set ID Numbers for Bus Devices*, page 39).
3. Toggle to the type (**NZE08** for an 8-zone expander), or select **NONE** to cancel its allocation and then press **OK**.
4. For the -zone expander, select its zone termination resistance by scrolling to the correct resistor values (in ohms).

NOTE: You define the termination resistance compatibility for the zone expander itself, according to the "highest" termination level of any relay detector you intend to connect to it. For example, if you have EOL, DEOL and TEOL detectors connected to the zone expander (or if you have only EOL and DEOL detectors, but you want to leave open the possibility of adding a TEOL detector to the zone expander in the future), you will need to set the zone expander's termination resistance values to TEOL – the "highest" level.

5. Press **OK** to advance to the next zone expander, and then repeat from step 2 for all additional zone expanders.

Utility Output Modules

1. From the **installer Programming menu**, select **7→1→2**, scroll to **03) Util. Output**, and then press **OK (✓)**.
2. Scroll to, and then edit the module's physical ID number to match its DIP switch settings (see *Describing Installer-Set ID Numbers for Bus Devices*, page 39).
3. Toggle to the UO type (or select **NONE** to cancel its allocation), then press **OK**.

Power Supply Modules

1. From the **installer Programming menu**, select **7→ 1→ 2**, scroll to **04)Power Supply**, and then press **OK (✓)**.
2. Scroll to, and then edit the power supply module's physical ID number to match its DIP switch settings (see *Describing Installer-Set ID Numbers for Bus Devices*, page 39).
3. Toggle to the PS type (or select **NONE** to cancel its allocation), and then press **OK**.
4. Select the partition number(s) for the power supply module. While scrolling through each block of partitions, designate the partition(s) to allow operation via the keypad. Enter a partition number to select it (it will display) or enter the number again to clear it (it will not display).
5. Press **OK**; 1)BELL/L.SPEAK N displays
6. Toggle between **Y** (yes) or **N** (no) for enabling or disabling the bell / loudspeaker, and then press **OK**.
7. Repeat from step 2 for all additional power supply modules.

Wireless Expanders

1. From the **installer Programming menu**, select **7→ 1→ 2**, scroll to **05)WL Expander** and then press **OK (✓)**.
2. Scroll to, and then edit the WL expander's physical ID number to match its DIP switch settings (see *Describing Installer-Set ID Numbers for Bus Devices*, page 39).
3. Toggle to **WM** (wireless module) or select **NONE** to cancel its allocation and then press **OK**.
4. Toggle to **Y** or **N** for bypassing the box tamper, then press **OK**.

Wireless Video Expanders

1. From the **installer Programming menu**, select **7→ 1→ 2**, scroll to **05)WL Expander** and then press **OK (✓)**.
2. Scroll to, and then edit the WL expander's physical ID number to match its DIP switch settings (see *Describing Installer-Set ID Numbers for Bus Devices*, page 39).
3. Toggle to **WVE** (wireless video expander) or select **NONE** to cancel its allocation and then press **OK**.
4. Toggle to **Y** or **N** for bypassing the box tamper, then press **OK**.

Wireless Security Modules

1. From the **installer Programming menu**, select **7→1→2**, scroll to **05)WL Expander**, and then press **OK (✓)**.
2. Scroll to, and then edit the WL expander's physical ID number to match its DIP switch settings (see *Describing Installer-Set ID Numbers for Bus Devices*, page 39).
3. Toggle to **WSM** (wireless security module) or select **NONE** to cancel its allocation and then press **OK**.
4. Toggle to **Y** or **N** for bypassing the box tamper, then press **OK**.

Proximity Key Readers

1. From the **installer Programming menu**, select **7→1→2**, scroll to **06)Prox Key Rd** and then press **OK (✓)**.
2. Scroll to, and then edit the physical ID number of the PKR (Proximity Key Reader) to match its DIP switch settings (see *Describing Installer-Set ID Numbers for Bus Devices*, page 39).
3. Toggle to **PRK** or select **NONE** to cancel its allocation, and then press **OK**; the Mask screen displays where you can enable operability of specific partition(s) when using this PKR.
4. While scrolling through each block of partitions, designate the partition(s) to allow operation via the PKR. Enter a partition number to select it (it will display) or enter the number again to clear it (will not display), then press **OK**.
5. Scroll through the various "Controls" options and toggle between **Y** and **N** for each, and then press **OK**.
6. Repeat this procedure from step 2 for all additional PKRs.

Voice Module

1. From the **installer Programming menu**, select **7→1→2**, scroll to **07)Voice Module**, and then press **OK (✓)**.
2. Toggle to **T=Voice** (the Voice Module) or select **NONE** to cancel its allocation), and then press **OK**.
3. Enter the 2-digit **R. Phone Code** (remote phone code), and then press **OK**.
4. Scroll to select a language for voice announcements, and then press **OK**.

Sounders (Sirens)

1. From the **installer Programming menu**, select **7 → 1 → 2**, scroll to **08)Sounder**, and then press **OK (✓)**.
2. Scroll to, and then edit the sounder's physical ID number to match its DIP switch settings (see *Describing Installer-Set ID Numbers for Bus Devices*, page 39).
3. Toggle to the type (or select **NONE** to cancel its allocation), and then press **OK**.
4. Select the partition number(s) for the sounder. While scrolling through each block of partitions, designate the partition(s) to allow operation via the keypad. Enter a partition number to select it (it will display) or enter the number again to clear it (it will not display).
5. Scroll to and select the partition number for the siren, and then press **OK**.
6. Select **Y** to enable the sound (or toggle to **N**), and then press **OK**.
7. Select **Y** or **N** for squawk sound, and then press **OK**.
8. Select **Y** or **N** for squawk strobe, and then press **OK**.
9. Repeat from step 2 for all additional sirens.

Bus Zones (Bus Detectors)

1. From the **installer Programming menu**, go to: **7 → 1 → 2 → 0 → 9 (Install → Bus Device → Manual → scroll to 09)Bus Zone**), and then press **OK (✓)**; the first available (non-allocated) bus zone displays as per this example (the empty fields in the parenthesis indicate that the zone has not yet been allocated):

```
Select (-:- -- :- -)
017) ZONE 017
```

2. Scroll to the zone that you want to allocate the bus zone to, then press **OK**; the following (example) displays:

```
BUS ZONE: (017)
(1:00:01) T=xxxx
```

EXPLANATION:

- **1** is the bus line number
- **00** is the bus zone expander ID (1–32) that the bus detector is connected to (00 means wired to a bus line at the main panel PCB)
- **01** is the installer-set physical ID number for the bus detector
- **T** is the type (description)

3. Scroll to and then edit the bus detector's physical ID number to match its DIP switch settings (see *Describing Installer-Set ID Numbers for Bus Devices*, page 39).
4. Toggle to the correct bus zone type (or select **NONE** to cancel its allocation), and then press **OK**; "Link Bus Input to Zone ###?" displays (whereas ### is the zone number).
5. To link (enable), toggle to **Y**, and then press **OK**.
6. Repeat this procedure for all additional bus detectors.

Bus Zone Expanders

1. From **Installer Programming** menu, go to: **7 → 1 → 2 → 11 (Install → Bus Device → Manual → Bus Expander)**; the 1st BZE (bus zone expander) displays (see *ID Number Formats*, page 40 for a description of the displayed BZE format).
2. Scroll to, and then edit the BZE's physical ID number to match its DIP switch settings (see *Describing Installer-Set ID Numbers for Bus Devices*, page 39).
3. Toggle to the type (or select **NONE** to cancel its allocation), then press **OK (✓)**.
4. Repeat from step 2 for all additional BZEs.

Step 4: Allocating Wireless Zones

Multiple 1-way and 2-way wireless detectors and accessories are connected to the system via wireless expansion modules – each of which supports multiple wireless zones and is connected to a RISCO bus line or at the main panel PCB.

NOTE: To set additional parameters, see *Installer Programming*, page 79.

Allocating Wireless Expanders

Wireless expanders must be allocated before their respective wireless devices.

➤ To allocate wireless expanders:

1. From the **installer Programming** menu, go to **7 → 1 → 2 → 0 → 5 (Install → Bus Device → Manual → WL Expander)**.
2. Scroll to, and then edit the WL expander's physical ID number to match its DIP switch settings (see *Describing Installer-Set ID Numbers for Bus Devices*, page 39).
3. Toggle to **WM** (to enable the Wireless Expander module) or **NONE** (to cancel its allocation), and then press **OK (✓)**.
4. Define whether to bypass the wireless expander box tamper by toggling between **Y** (to bypass) and **N** (to not bypass), and then press **OK**.

Allocating Wireless Devices





Allocate each wireless transmitting device via keypad or CS – either by sending an RF transmission or enter the device’s 11-digit code (see sticker on device for code).





Allocating Wireless Devices via RF Transmission

➤ **To allocate a wireless device via RF transmission:**

1. From the installer **Programming menu**, go to **7 → 2 → 2 → 1 → 1 (Install → WL Device → Allocation → By RF → Zone)**.
2. If you have multiple wireless receivers, scroll to the first one for which you wish to allocate it’s wireless devices, and then press **OK (✓)**; Each zone appears in one of the following formats: “**Select (—:— — —:— —)**” which indicates the zone is available for allocating, or “**Select (3:E02:06)**” which, in this example, indicates the zone has already been allocated.
NOTE: Allocating the same WL zone again will re-write (cancel) prior allocation.
3. Scroll to the zone number you want to allocate (or enter the zone number using 3 digits – for example enter 022 for zone 22), and then press **OK**; the wireless expander is now in “learn” mode for the next 180 seconds.
4. Per the table below, within the remaining time, send an RF transmission from a wireless device that you want to sync with the selected wireless expander. If “write message not found” displays, it means the transmission was not received and the device didn’t get allocated.

Wireless Device RF Transmissions

Wireless Device (1-way and 2-way)	To send an RF transmission:
Detectors: <ul style="list-style-type: none"> • WatchOUT • BWare • iWave • iWise • Door-Window Contacts (Dual Channel, Pulse Count, Universal) • Shock • Glassbreak 	Insert battery. Press and hold the tamper switch for at least 3 seconds.
Smoke & heat detectors	Insert battery. Transmission is sent automatically within 10 seconds.
Gas detectors	Insert battery. Within 10 seconds, press and hold the test button for 3 seconds.
CO detectors	Insert battery. Within 10 seconds, press and hold the test button for 3 seconds.
Flood detectors	Insert battery. Press both tamper buttons (back and cover) for at least 3 seconds.
WL beams	Insert battery. Press the tamper spring for 5 seconds. Observe DIP switch settings according to model and tamper usage.
Sirens (Round Indoor siren, Lumin8 siren, Outside sirens)	Insert battery. Within 10 seconds, press and hold the tamper switch for 3 seconds.
2-way, 8-button remote control	Press both buttons ( and ) for at least 7 seconds.
2-way, Panda 4-button keyfob	Press both buttons ( and ) for at least 2 seconds.
4-button rolling code keyfob	Press and hold  for at least 5 seconds (the LED lights up twice during the 5 seconds - the second time indicates the transmission is being sent).
2-button panic keyfob	Press both buttons for at least 7 seconds.
Wristband panic transmitter	Press the button for at least 7 seconds. The red LED lights up during transmission.

Wireless Device (1-way and 2-way)	To send an RF transmission:
2-Way WL Slim Keypad	Press and hold both buttons ( and ) for at least 2 seconds.
2-Way Panda Keypad	Press and hold both buttons ( and ) for at least 2 seconds.

- Repeat from step 3 for each additional wireless transmitting device to be allocated for this wireless expander.
- After you have allocated the devices for this specific wireless expander, repeat the procedure from step 2 for all additional wireless expanders (and then their respective transmitting devices).
- Now define the basic parameters for the wireless zones, such as labels, partitions, etc. (see *Step 5: Basic Zone Configuration for All Zone Types, page 66*).
- After, it may be beneficial to perform advanced programming such as measuring and setting the background noise threshold level, followed by performing a wireless communication test (see *Advanced Programming for Wireless Zones, page 69*).

Allocating Wireless Devices via Code

➤ To allocate a wireless device via the device's code:

- From the **installer Programming menu**, go to **7 → 2 → 2 → 2 (Install → WL Device → Allocation → By code)**
- Scroll to the zone or wireless device type [keyfob, keypad, sounder].
NOTE: See table above for specific wireless device types.
- If you have multiple wireless receivers scroll to the first one for which you wish to allocate it's respective wireless devices.
- Press **OK (✓)**; Each zone/device appears in one of the following formats:
"Select (—:— — —:— —)" which indicates it is available for allocating, or
"Select (3:E02:06)" which, in this example, indicates it has already been allocated.

NOTE: If you try to allocate the same wireless zone number/device twice, the second allocation will over-write the prior allocation

5. Scroll to the zone number/device you want to allocate (or enter the zone number using 3 digits – for example enter 022 for zone 22), and then press **OK**; Z=xxx (RE) WRITE: 0000000000 displays (whereas xxx = the zone number). For devices, the device name, number and (RE) WRITE: 0000000000 display.
6. Enter the 11-digit code of the wireless device to enroll, and then press **OK**; the zone number and device description appears if successfully allocated.

Step 5: Basic Zone Configuration for All Zone Types

Defining Basic Parameters

You can define basic parameters for all types of zones. The relevant parameters display dynamically according to the respective zone type.

You can define all the various zone parameters for one zone at a time by using the “**One By One**” option, or you can take a specific parameter and define it accordingly for multiple zones by using the “**By Category**” option. Also, you may need to define the zone’s termination resistance (“**Resistance**” option) if using relay detectors and zone expanders.

After defining the basic zone parameters, you can define advanced parameters for bus zones and wireless zones (see *Step 6: Advanced Zone Configuration for Bus Zones and Wireless Zones*, page 69).

Describing Zone Information Displayed at the Keypad

At the keypad you will be entering the zone information which will be displayed as per this example: **Z=125 (1:E03:06)**:

EXPLANATION:

- **Z=125** is the zone’s index number (up to 512 zones possible)
- **1** is the RISCO bus line number (1–4)
- **E03** is the expansion module ID (shows as E00 if wired at the terminal block)
- **06** is the zone’s installer-set physical (and sequential) ID number

Defining Zone Parameters using the “One-By-One” Option

This option lets you to define all zone parameters, for one zone at a time.

➤ To define zone parameters using the One-By-One option:

1. From the **installer Programming menu** go to: **2 → 1 → 1 (Zones → Parameters → One by One)**; the first zone (Z=001) displays in the format described above.
2. Using the numeric keys, you can change the zone’s 3-digit zone number to the one for which you want to define its parameters, and then press **OK (✓)**.
3. You can now define the following parameters for this specific zone (moving from one parameter type to another by pressing **OK**):
 - a. **[Labels]:** Give the zone a descriptive “label” by typing over the default “ZONE” (see *Designating Labels, page 50*), and then press **OK**.
 - a. **[Partitions]:** To select partitions (up to 32) to associate with the zone, scroll to the partitions, which are grouped in blocks: the first block contains partitions 01–08 (the default) if that is what was enabled. If additional partitions were enabled, scroll to all the blocks (of ten) they are located in: block 01–10, 11–20, 21–30, and 31–32. In each block, enter the relevant partition number/s (each will display as P=#) and then before pressing **OK**, scroll to the next blocks and do the same. When finished, press **OK**.
 - b. **[Group]:** A group is a specific area (zone) that can be armed within a specific partition – up to 4 groups [A–D] maximum per each partition. For each group letter, toggle between **Y** (select) and un-select, then scroll to the next group letter, if needed. When finished press **OK**.
 - c. **[Zone Type]:** Scroll to select the zone type (35 zone types), then press **OK**.
 - d. **{Arm Sound}:** Scroll to select an arming sound, and then press **OK**.
Options: silent, bell only, buzzer only, bell+buzzer, door chime.
 - e. **[Stay (Partial Arm) Sound]:** Scroll to select a partial arming sound, then press **OK**. Options: silent, bell only, buzzer only, bell+buzzer, door chime.
 - f. **[Disarm Sound]:** Scroll to select the disarming arm sound for this zone, and then press **OK**. Options: **silent, door chime**.
 - g. **[Terminate]:** For wired relay-detector zones only. Scroll to select the zone termination type, then press **OK**. Options: **NC, EOL, DEOL, N/O, TEOL**.
 - h. **[Response]:** Scroll to select zone response time, then press **OK**. Options: **NORMAL (400 ms), LONG (1 sec.), FAST (10 ms), and E. FAST (1 ms)**.
4. Press **OK** to go to the next zone and repeat the procedure for all other zones.

Defining Zone Parameters using the “By Category” Option

For a specific parameter type, this lets you to define it accordingly for multiple zones (as you go from one to another, scrolling through all zones in the system).

➤ To define zone parameters using the By-Category option:

1. From the **installer Programming menu** go to: **2 → 1 → 2 (Zones →Parameters →By Category)**.
2. Scroll to arrive to the parameters and their respective options to modify. Parameters: **Label, Partition, Type, Sound, Termination, Loop Response, Advanced**. Press OK (✓) to confirm after each selection. Use the numeric keys to enter the zone number (or numeric values) where needed.

Defining Zone Termination Resistance using the “Resistance” Option

Regardless of which method was used to define zone parameters (One-by-One, or By Category), if you had specified zone termination in the Termination parameter (relevant for wired zones only), you have only specified what **type** of termination configuration to apply for the wired zone – EOL, DEOL, TEOL, NC, or NO. In the Resistance option, you now define the **termination resistance value(s)** for the wired zone.

If using a zone expander (8-zone, single-zone), in addition to defining the termination resistance for all the relay detectors connected to it – which can be any combination of EOL, DEOL, TEOL detectors – you also need to define the termination resistance compatibility for the zone expander itself, according to the “highest” EOL level of any relay detector you intend to connect to it. For example, if you have EOL, DEOL and TEOL detectors connected to the zone expander (or if you have only EOL and DEOL detectors, but you want to leave open the possibility of adding a TEOL detector to the zone expander in the future), you will need to set the zone expander’s termination resistance values to TEOL – the “highest” level.

Default termination resistance values for RISCO relay detectors are:

- **EOL (end-of-line):** 2.2K Ω
- **DEOL (double end-of-line):** 2.2K Ω , 2.2K Ω
- **TEOL (triple end-of-line):** 4.7K Ω , 6.8K Ω , 12K Ω

NOTE: For retrofit installations, you can define the resistance compatibility according to the resistors already installed in the relay detectors.

➤ To define zone termination resistance values:

1. At **Programming menu** go to: **2 → 1 → 3 (Zones→Parameters→Resistance)**
2. Scroll to the detector-compatible termination resistance option, then press **OK**.

Zone Termination Resistance Values (in Ohms)

	EOL	DEOL	TEOL		EOL	DEOL		EOL	DEOL
00	Custom			05	3.74K	6.98K	10	3.3K	3.3K
01	2.2K (default)	2.2K, 2.2K (default)		06	2.7K	2.7K	11	5.6K	5.6K
02	4.7K	6.8K	4.7K, 6.8K, 12K, (default)	07	4.7K	4.7K	12	2.2K	1.1K
03	6.8K	2.2K		08	3.3K	3.3K	13	2.2K	4.7K
04	10K	10K		09	1K	1K			

Step 6: Advanced Zone Configuration for Bus Zones and Wireless Zones

NOTE: To set additional parameters, see *Installer Programming*, page 79.

Advanced Programming for Bus Zones

➤ Configuring advanced parameters for bus zones:

1. At the installer **Programming** menu, go to: **2→1→2→7→4 (Zones→Parameters→By Category→Advanced→BZ Parameters)**, then press **OK (✓)**.
2. Scroll to the bus zone number to program, and then press **OK**.
3. Scroll through the options and configure the relevant parameters for the zone, pressing **OK** after each to confirm.

Advanced Programming for Wireless Zones

➤ Configuring advanced parameters for wireless zones:

1. At the installer **Programming** menu, go to: **2→1→2→7→5 (Zones→Parameters→By Category→Advanced→WL Parameters)**, then press **OK (✓)**.
2. Enter the wireless zone number to program, and then press **OK**.
3. Scroll through and configure the relevant parameters for the zone, pressing **OK** after each to confirm.

Measuring Background Noise Level and Defining the Threshold Limit

If the system uses wireless devices, you can measure (“calibrate”) the background noise that the main panel detects, and also define the acceptable threshold value.

Background noise (RF interference) is typically generated by other non-system devices operating in close proximity to the system, and high amounts may interfere with the system, causing “jamming.” Communication between your system’s wireless devices (via wireless expander module/s) and the main panel must be stronger than any detected background noise at the main panel, therefore regardless if the current level of background noise the panel detects seems insignificant, it is recommended to additionally perform a Wireless Communication Test, to check a wireless device’s signal (see *Performing a Wireless Comm. Test for Measuring Signal Strength*, page 71).

Measuring the background noise level provides an indication whether the main panel is mounted at a good location.

Defining the threshold limit value enables you to determine how much background noise your system will tolerate before it generates jamming events. The lower you define the threshold value, the more “sensitive” the system will be (it will report jamming events more frequently), and the higher you define the threshold value, the less sensitive the system will be (it will report jamming events less frequently).

➤ **To calibrate (measure) the background noise:**

1. From the **Installer Programming menu**, select **7→2 →1 (Install→WL Device→RX Calibration)**; CHOOSE RECEIVER (wireless expander) displays.
2. Scroll to select the wireless expander module, and then press **OK (✓)**; the most recently measured result (“THOLD”) for that wireless expander module displays.
3. To re-calibrate (re-measure) the background noise, toggle to **Y (yes)**, and then press **OK**; the new result (“NEW THOLD”) displays.
4. Press **OK** to confirm. If the resulting value is not acceptable, for example if it is high due to what you believe is a source of high background noise that’s inherent to the main panel’s location, then you may want to move the main panel to a better location. Another option you may consider is to re-define the noise level threshold value (see the following procedure).

➤ **To define the noise level threshold value:**

1. From the **installer Programming menu**, select **7→2→1 (Install→WL Device→RX Calibration)**; **CHOOSE RECEIVER** (wireless expander) displays.
2. Scroll to select the wireless expander module, and then press **OK (✓)**; the most recently measured result (“THOLD”) for that Wireless Expander module displays.
3. Toggle to **N (no)**, and then press **OK**; the most recently measured result displays again, over which you can now enter a new threshold value (between **11–86**), and then press **OK**.

Performing a Wireless Comm. Test for Measuring Signal Strength

A Wireless Communication test result (the signal strength between the wireless device and the main panel) must be higher than the background noise measured at the main panel. If the background noise level is higher, you will most likely need to move the wireless device to a better location.

➤ **To perform a Wireless Communication test:**

1. Exit the installer Programming menu (see *Exiting Installer Programming Menu after Initial System Programming*, page 217).
2. Ensure all wireless devices are activated.
3. Enter the installer code (default is **1111**), and then press **OK (✓)**.
4. Scroll to **Maintenance**, then press **OK**; you are in installer Maintenance menu.
5. Scroll to **Wireless Test**, then press **OK**; **Zones** displays.
6. At **Zones**, press **OK**; **Comm. Test** displays.
7. At **Comm. Test**, press **OK**.
8. Scroll through all wireless zones to view each of their results. The test results range from **11** (lowest) to **86** (highest), and display as per this example:

<p>ZONE 025 001) ZONE 025:86</p>

EXPLANATION:

001= Wireless device index number, 025=zone: 86 = result (signal strength)

Step 7: Configuring System Communication

NOTE: To set additional parameters, see *Installer Programming*, page 79.

Defining Primary Communication Channels & Parameters

➤ To define the primary communication channel:

1. From **Installer Programming** menu go to: **5) Communication menu** → **1) Method**.
2. Scroll to the primary communication channel: **(GSM, IP)**, then press **OK**.
3. Scroll through the respective parameters (see the table below), and define the relevant ones, pressing **OK** after each parameter that is set.

NOTES:

- You can connect to the Cloud and additional destinations/monitoring station in parallel, using a single multi-socket communication module (IP, GSM 2G, GSM 3G or GSM 4G).
- For setting the backup communication channel to the monitoring station, see *Defining Monitoring Station Account Parameters*, page 73.
- LightSYS Plus menus reflect only the communication modules that are installed.
- For IP communication, you can set it to Dynamic IP or Static IP. See *Setting Dynamic IP / Static IP*, page 56.
- To establish GPRS/3G/4G communication, a SIM card must be installed.

Primary Comm. Channel	Parameters
GSM	1) Timers → 1)GSM Lost, 2)GSM Net Loss, 3)SIM Expire, 4)MS Polling [Primary, Secondary, Backup] 2) GPRS → 1)APN Code, 2)APN User Name, 3) APN Password 3) Email → 1)Mail Host, 2)SMPT Port, 3)Email Address, 4)SMPT UserName, 5)SMPT Password 4) Controls → 1)Caller ID (Y/N) 5) Parameters → 1)PIN Code, 2)SIM Number, 3)SMS Centre PH, 4) GSM RSSI [Disable, Low signal, High signal] 6) Prepay SIM → 1)Get Credit By [Credit SMS, Credit Voice, Service Cmnd], 2)PN To Send, 3)PN to Receive, 4)SMS Message
IP	1) IP Config → 1)Obtain IP [Dynamic IP, Static IP], 2)Panel Port 2) E-mail [Mail Host, SMTP Port, Email Address, SMTP Name, SMTP Password], 3) Host Name [Security_System] 4) MS Polling [Primary, Secondary, Backup]

Defining Communication with the Monitoring Station

You enable and define communication settings for monitoring station account(s), along with the backup communication channel and other associated parameters that define the nature of communication, event reporting and confirmation between the system and the monitoring station. Monitoring station link-up options are via TCP/IP, and GSM/GPRS/3G/4G.

Enabling Monitoring Station Communication

- **To enable monitoring station communication:**
 1. From **Installer Programming menu** go to: **1)System → 2)Controls → 3)Communication → 1)MS Enable**.
 2. Press  to scroll to **Y**, and then press **OK (✓)**.

Defining Monitoring Station Account Parameters

- **To define parameters for a monitoring station account:**
 1. From **installer Programming menu** go to: **5)Communication → 2)MS → 1)Report Type**; MS1 (MS account 1) displays.
 2. Scroll to the MS account number you want to define, and then press **OK (✓)**.
 3. Scroll to select the reporting type (**Voice, IP, SMS, SIA IP**), and then press **OK**; the available primary/backup communication channel options appear (according to the primary communication channel already selected).
 4. Scroll to select from the primary/backup communication channel options, and then press **OK**. Note that if “GSM Only,” or “IP Only” is selected, it will not have a backup communication channel.
 5. Enter any needed parameters, and then press **OK**. Note that “GSM Only” means there will be no backup communication channel for this primary channel.
 6. Go to: **5)Communication → 2)MS → 2)Accounts**, scroll to select an account number to define, enter its account number, and then press **OK**.
 7. Go to: **5)Communication → 2)MS → 3)Comm Format**, and then press **OK**. Scroll to select a transmission format (**Contact ID** or **SIA**), and then press **OK**.
 8. Go to: **5)Communication → 2)MS →** scroll to and define other options as needed: **4)Controls, 5)Parameters, 6)MS Times, 7)Report Split, 8)Report Codes**.
 9. Repeat the procedure for all other monitoring station accounts used.

Step 8: Configuring Cloud Connectivity

The RISCO Cloud is RISCO's application server that handles all communication between the system, monitoring station, as well as system users (for the Smartphone and Web apps). Cloud communication enables remote monitoring and control of the system, sending event notifications, and viewing real-time video verification via RISCO's VUpoint IP cameras.

NOTE: To set additional parameters, see *Installer Programming*, page 79.

Enabling / Disabling Cloud Communication

The system is Cloud-enabled by default.

➤ **To enable or disable Cloud communication:**

1. From the **Installer Programming** menu go to: **1)System → 2)Controls → 3)Communication → 4)Cloud Enable [N]**.
2. Toggle between **Y** and **N** to enable/disable Cloud communication, and then press **OK (✓)**.

Defining RISCO Cloud Connectivity

If using IP and/or GSM modules, you need to define the network connectivity to the RISCO Cloud server.

➤ **To define network connectivity to the RISCO Cloud:**

1. With Cloud communication enabled (default), from the **Installer Programming** menu go to: **5)Communication menu → 5)Cloud**
2. Scroll to, and define parameters for the following as needed (note that customer-specific parameters may differ):
 - **1) IP Address:** (default is riscocloud.com)
 - **2) IP Port:** (default is 33000)
 - **3) Password:** Password for server access (default is **AAAAAA**).
 - **4) Channel:** Select **IP Only** or **GSM Only**, depending on the installed communication modules in the panel.
 - **5) Controls:** Toggle between **Y** and **N** to enable/disable MS Call All, FM Call All, App Arm, and App Disarm.

Step 9: Configuring Common System Parameters

NOTE: In addition to defining these common system parameters, see *Installer Programming, page 79* for programming all other parameters in the Installer Programming menu, as well as in the other installer menus.

Defining System Users

As the installer, you must set up the user codes for all the **system users** (up to 500 codes total, which includes 499 users including the Grand Master, plus the installer). Performed from a wired keypad or from the CS, you configure the code length and the authority levels (permissions) for the system users as determined by the Grand Master (the default authority level is **User**). The Grand Master will select the numerical codes for each user from a wired keypad or the Web user interface. The installer can also change the default installer and Grand Master codes.

NOTE: You designate the code lengths to be either 4 or 6 digits in length. If defined as 6 digits, the length applies for everybody - all users/installers. However, if defined as 4 digits, Grand Master, Installer, and Sub-Installer must have 4-digit codes, while the system users can have codes of various lengths, from 1–4 digits.

Defining User Codes

➤ To define user codes:

1. From **Installer Programming menu** go to: **4)Codes→1)User** then press **OK** (✓).
2. Scroll to a user's index number (1–500 users possible), then press **OK**; the user number and "1) Partition" display.
3. Press **OK**. To assign partition(s) this user will be allowed to operate, do the following:
 - a. While scrolling through each increment of 10 partitions, select partition(s) to allow operation by this user. Enter a partition number to select it (it will display) or enter the number again to clear it (it will not display).
 - a. When finished selecting all partition numbers press **OK**.
4. To assign an authority level for this user, do the following:
 - a. After assigning partitions (step 3), scroll to **2)Authority**, then press **OK**.
 - b. Press  to scroll to the authority level for this user (**User, Arm Only, Maid, Unbypass, Guard, Duress, UO Control, Master**), then press **OK**.

NOTE: "Duress" is not an authority level, but a feature available to all users. By selecting this option (use any available user index number) the Grand Master will then assign a code that all users can use in times of duress, where they are forced to disarm the system. The monitoring station is sent an alarm, but the panel is silent.

Changing the Default Installer Code

The default installer code is **1111**. You can either use this code during system programming, or you can change it.

➤ To change the installer code:

1. From the **Installer Programming menu** select **4)Codes → 3)Installer**, and then press **OK (✓)**; CODE: 1111 displays.
2. Scroll to each digit as you overwrite with a new code, and then press **OK**.
3. Re-enter the new code, and then press **OK**.

Changing the Default Grand Master Code

The default Grand Master code is **1234**, which can be changed by the installer. Be sure to advise the customer that that after system installation, the primary system user (“Grand Master”) should change the Grand Master code to be unique and confidential (refer to the LightSYS Plus User documentation).

➤ To change the default Grand Master code:

1. From the **Installer Programming menu** select **4)Codes → 2)Grand Master**, and then press **OK (✓)**; **** displays.
2. Scroll through the asterisks and enter a new code over them, and then press **OK**.

Resetting the Installer, Sub-Installer and Grand Master Codes to Default Codes

You can reset the Installer, Sub-Installer and Grand Master Codes to default codes.

➤ To change to default codes:

1. Restart the panel.
2. Press  + 8 simultaneously on the keypad; a unique 15-digit number displays.
3. Obtain the required reset key (8 digits) from the HandyApp, RISCO Cloud or RISCO Customer Support.
4. Enter the reset key in the keypad.

The Installer/Sub-Installer/Grand Master Code will be set to the default code.

Defining Follow Me Destinations

You can enable and define up to 64 Follow-Me destinations.

NOTE: The actual telephone numbers and email addresses for FM destinations are defined by the Grand Master in the User menu.

Enabling Follow Me

➤ **To enable using Follow Me destinations:**

- From the Installer Programming menu go to: **1)System → 2)Controls → 3)Communication → 2)FM Enable**, toggle to **Y** to enable (or to **N** to disable), and then press **OK (✓)**.

Defining Follow Me Parameters

➤ **To define parameters for a Follow Me destination:**

1. From the **Installer Programming menu** go to: **5)Communication menu → 4)Follow Me → 1)Define FM**; Follow Me 01 displays (1st FM destination).
2. Scroll to a FM number to define, and then press **OK (✓)**.
3. Scroll through the following options and define them as needed: **Report Type, Partition, Events, Restore Events, Remote Control**.

Defining System Timers

➤ **To define system timers:**

1. From the **Installer Programming menu**, select **1)System → 1)Timers**
2. Scroll to select from the options and modify their parameters as needed.

Defining All Additional Parameters

For defining all additional system parameters in the installer Programming menu, as well as in other installer menus, see the next section (Installer Programming).

IMPORTANT:

- After you have finished programming all relevant parameters in the Installer Programming menu **at the time of initial system setup**, you must then perform the procedure to exit the installer Programming mode. See *Exiting Installer Programming Menu after Initial System Programming*, page 217.
- For accessing the Installer Programming menu again after initial system setup (after you have performed the procedure to exit installer Programming mode) see page 217.

- To restore the system's factory defaults, see *Restoring Manufacturer's Programming Defaults*, page 219.

Installer Programming

LightSYS Plus can be programmed by the installer using the following:

- **Wired keypad**
- **Configuration Software** (locally or remotely connected – see the CS documentation).

When performing installer programming in the various installer menus, some of the parameters display dynamically, meaning that the keypad will only display the parameters for the respective modules/hardware that are installed.

IMPORTANT: After finishing to work in the Installer Programming menu the first time (for initially programming the system), you must then exit the menu. See *Exiting Installer Programming Menu after Initial System Programming, page 217*.

Defining Parameters – Installer Programming Menu

This section describes all parameters contained in the Installer Programming menu, including the common definitions described prior in this manual.

The Installer Programming menu consists of the following sub-menus:

- ① System
- ② Zones
- ③ Outputs
- ④ Codes
- ⑤ Communication
- ⑥ Audio
- ⑦ Install
- ⑧ Devices
- ⑨ Exit

① System

The System sub-menu contains the following programmable parameters:

- **Timers**
- **Controls**
- **Labels**
- **Sounds**
- **Settings**
- **Automatic Clock**
- **Service Information**
- **Firmware update**

①① Timers

The Timers parameters specify the time duration of an operation.

System → Timers

Quick keys	Parameter	Default	Range
①①①①	Exit/Entry Delay 1		
	Exit/Entry delays (Group 1).		
①①①①①	Entry Delay 1	30 seconds	01 – 255 seconds
	Duration of entrance delay 1.		
①①①①②	Exit Delay 1	45 seconds	01 – 255 seconds
	Duration of exit delay 1.		
①①①②	Exit/Entry Delay 2		
	Exit/Entry delays (Group 2).		
①①①②①	Entry Delay 2	30 seconds	01 – 255 seconds
	Duration of entrance delay 2		
①①①②②	Exit Delay 2	45 seconds	01 – 255 seconds
	Duration of exit delay 2.		
①①①③	Bell Timeout	04 minutes	01 – 90 minutes
	Duration of the external sounder(s) during alarm.		

Quick keys	Parameter	Default	Range
①①④④	Bell Delay	00 minutes/seconds	00—90 minutes/seconds
	The time delay before the keypad sounder and the external sounder operate after the onset of an alarm.		
①①⑤⑤	Switch Aux Break	10 seconds	00—90 seconds
	The time that the power supplied to the system's smoke detectors through the programmable output is interrupted during a user-initiated smoke detector reset, typically performed after a fire alarm or automatically when the fire verification is defined in the system control (see <i>Double Verification of Fire Alarms</i> , page 88 for additional details).		
	Note This feature is supported through any programmable output that is defined as Switch AUX.		
①①⑥⑥	Wireless		
	Specifies the time intervals relating to the operation of the wireless module.		
①①⑥⑥②	RX Supervise	0	0—7 hours
	Specifies how often the system expects to get a signal from the system's transmitters. If a signal from a zone is not received during the specified time the zone will be regarded as lost, the system will send a report code to the monitoring station, and the system status will be "Not Ready."		
	Note Setting to 0 hours disables supervision. It is recommended to set the supervision time to a minimum of 3 hours		
①①⑥⑥③	TX Supervise	058	1-255 minutes
	Specifies how often a 2-way wireless device generates a supervision request to the system. If any accessory doesn't respond to the request at least once during the RX Supervision time, the system will regard the accessory as Lost.		
	Note Device will generate the supervision message according to the time defined.		
	Important The RX Supervision time should be higher than the TX Supervision time in order to eliminate a false lost event.		
①①⑥⑥④	Service Mode	020	1-255 minutes

Quick keys	Parameter	Default	Range
	The time period that all tampers (main unit and accessories) can be opened for purposes of battery replacement without triggering a tamper alarm.		
①①⑦	AC Off Delay	30	000–255 minutes
	In the case of a loss of AC power, this parameter specifies the delay period before reporting the event or operating the programmable output. If the delay time is set to zero, there will be no delay period.		
①①⑧	Guard Delay	30	01–99 minutes
	Specifies the time period that the system will be unarmed after an authorized user enters a Guard code.		
①①⑨	Swinger Limit	00	00–15 times
	A swinger is a repeated violation of the same zone, often resulting in a nuisance alarm and usually due to a malfunction, an environmental problem, or the incorrect installation of a detector or sensor. This parameter specifies the number of violations of the same zone reported during a single armed period, before the zone is automatically bypassed.		
	Notes <ul style="list-style-type: none"> • Enter 00 to disable the swinger shutdown. • The zone will be unbypassed automatically after 24 hours or at disarm. • EN 50131 compliance with swinger limit of no more than 10 times 		
①①⑩	Redial Wait	30	0–255 seconds
	The number of seconds between attempts at redialing the same phone number. Applies to the parameter MS Retries, page 179, and Follow Me Retries, page 195.		
①①⑪	Last Exit Sound	10	01–255 seconds
	Defines the final seconds of the Exit Time for which the beep sound will change (at keypads), indicating that Exit Time period is about to expire.		
①①⑫	Buzzer at Stay	15	01 – 99 seconds
	Defines how much time the keypad’s buzzer will sound before the external sounders start to operate while an alarm occurs in Stay (partial arming) mode. The timer is relevant only if the system control Bell → Buzzer is defined as Yes.		

Quick keys	Parameter	Default	Range
①① 13	Status Timer	000	0–255 seconds
	<p>Defines if the system status will be displayed while the system is armed. When the time is defined as 0, the system status will be displayed during the arming period. When the time is not 0, the system status will be displayed only during this interval after the arming period starts.</p>		
①① 14	Service Timer	000	0–255 weeks
	<p>Use this timer to periodically generate a “service required” message so that the user is reminded that a service call is required. The user may continue to arm and disarm the system. When this time is other than 0, the panel will count down the time. When the time expires, a service message will be displayed on all LCD keypads whenever the keypad is on Disarm display. To clear the message, the installer needs to reset the time, enter a code from the Anti Code menu or perform a “remote reset” to the panel.</p>		
①① 16	Pulse Open	00 sec	0–255 seconds
	<p>This timer is relevant only for zones defined with a pulse counter greater than one. See <i>Pulse Counter</i>, page 120 (②①②⑦2).</p> <p>If such a zone is regarded as not ready for the time defined under this timer, then the zone will be tripped and act according to its type definition.</p>		
①① 17	Inactivity Timer	0	0–255 minutes
	<p>This timer relates to the Automatic Arm/Disarm scheduler. If there is no signal from any of the zones located in a partition that is defined under an Arm/Disarm scheduler for the time defined as Inactive Timer, then the automatic schedule will be activated and the relevant partitions will be auto-armed (according to the schedule definition).</p> <p>Note Inactive Timer of scheduling program should be defined as ON under: User Menu → Clock → Scheduler → Weekly → Schedule# → Arm/Disarm → 6)Inactive</p>		
①① 18	Timeout Beeps	15	0-60 minutes
	<p>Beeping sound indication for timeout</p>		

①② Controls

The Controls sub-menu has the following configurable parameters:

- Basic
- Advanced

- Communication
- EN 50131
- PD6662
- CP-01
- Device

System → Controls → Basic

Quick keys	Parameter	Default	Range
①②①	Basic Programming		
	This section refers to the most common controls in the system.		
①②① 0 1	Quick Arm	Yes	Yes/No
	YES: Eliminates the need for a user code when arming (full or partial). NO: A valid user code is required for arming (full or partial).		
①②① 0 2	Quick UO	Yes	Yes/No
	YES: A user can activate a utility output without the need to enter a user code. NO: A user code is required to activate a utility output.		
①②① 0 3	Allow Bypass	Yes	Yes/No
	YES: Permits zone bypassing by authorized system users after entering a valid user code. NO: Zone bypassing is not permitted.		
①②① 0 4	Quick Bypass	No	Yes/No
	YES: Eliminates the need for a valid user code when bypassing zones. NO: Qualified users must enter a valid user code to bypass zones.		

Quick keys	Parameter	Default	Range
①②① 05	False Code Trouble	Yes	Yes/No
	<p>YES: A false code report is sent to the monitoring station after three successive attempts at arming or disarming in which an incorrect user code is entered. No alarm sounds at the premises, but a trouble indication appears on the wired keypads.</p> <p>NO: A false code report is sent to the monitoring station and a local alarm is sounded at the premises.</p> <p>NOTE: Above Grade 2, after 10 invalid code entry attempts the keypad will lock for 90 seconds (relevant for all user codes and operations – arming, disarming, etc.). This feature is automatically activated, and there are no parameters to set for it.</p>		
①②① 06	Bell Squawk	Yes	Yes/No
	<p>YES: Arming or disarming the system using a remote control, wireless keypad or a keyswitch produces a brief “chirp” and activates the strobe as follows:</p> <ol style="list-style-type: none"> 1. One chirp indicates the system is armed 2. Two chirps indicate the system is disarmed. 3. Four chirps indicate the system is disarmed after an alarm. <p>NO: No “chirp” is produced.</p>		
①②① 07	3 Minute Bypass	No	Yes/No
	<p>YES: Bypasses all zones automatically for three minutes when power is restored to an “unpowered” system to allow for the stabilization of motion and/or smoke detectors.</p> <p>NO: No bypassing occurs.</p>		
①②① 08	Audible Panic	No	Yes/No
	<p>YES: The sirens operate when a “panic alarm” is initiated (if defined) at the keypad, at the remote control, or when a panic zone is activated.</p> <p>NO: No siren operation occurs during a panic alarm, making the alarm truly “silent” at the premises (Silent Panic).</p> <p>Note The system always transmits a panic report to the monitoring station.</p>		
①②① 09	Buzzer → Bell	No	Yes/No
	<p>YES: If an alarm occurs when the system is armed in the Stay arm (partial arm) mode, a buzzer sounds for the time defined under Buzzer At Stay (see <i>Buzzer at Stay page 82</i>) before the external sirens operate.</p> <p>NO: An alarm in the Stay Arm (partial arm) mode causes sirens to operate simultaneously.</p>		

Quick keys	Parameter	Default	Range
①②① ①①	Enable Jamming	No	Yes/No
	<p>YES: Enables jamming alarm in system. NO: Disables jamming alarm in system.</p>		
①②① ①①	Audible Jamming	No	Yes/No
	<p>YES: Once the specified 30 seconds time is reached, the main panel activates any internal sounders and sends a report code to the monitoring station. NO: Same as above, except the internal sounders do not operate.</p>		
①②① ①②	Exit Beeps at Stay	No	Yes/No
	<p>Determines whether the system will sound beeps during the exit time when in Stay arming (partial arming). YES: Exit beeps will sound. NO: Exit beeps will not sound.</p>		
①②① ①③	Forced Keyswitch Arming	Yes	Yes/No
	<p>YES: Keyswitch, Keyfob or Proximity Key arming (only from PKR) is performed on any partition. Any violated ("Not Ready") zones in the partition will be bypassed automatically. The partition is then "force-armed," and all intact zones are capable of producing an alarm. NO: The partition cannot be armed until all violated ("Not Ready") zones are secured.</p>		
①②① ①④	Arm Pre-Warning	No	Yes/No
	<p>Related to auto arm/disarm operation. YES: For any partition(s) set up for auto arming, an audible exit delay (warning) countdown will commence 4:15 minutes prior to the automatic arming. During this period, exit delay beeps will be heard. You can enter a valid user code at any time during the countdown to delay the partition's automatic arming by 45 minutes. When an "Auto-Arm" partition is disarmed, as described above, it can no longer be automatically armed during the current day. The extended 4:15 minutes warning does not apply to automatic partial arming. NO: Auto arming for any programmed partition(s) takes place at the designated time. The programmed exit delay period and any audible signal occur as expected.</p>		

System → Controls → Advanced

Quick keys	Parameter	Default	Range
①②②	Advanced		
	This section refers to the advanced controls in the system.		
①②② ①①	Double Verification of Fire Alarms	No	Yes/No
	<p>YES: Implemented on detection of smoke or fire for verification. Power to the smoke detector(s) in the affected zone is cut off and restored after the time defined in the Switch Aux Break delay (Switch Aux Break, page 81). If a subsequent detection occurs in the same zone within one minute at the end of the Switch Aux time, the system emits a fire alarm.</p> <p>NO: No fire alarm verification takes place.</p>		
①②② ①②	Alarm Zone Expander Cut	No	Yes/No
	<p>YES: Produces an alarm if the communication between the main panel and any expander is lost. A report is transmitted to the monitoring station.</p> <p>NO: No alarm occurs. The system, however, produces a local trouble indication.</p>		
①②② ①③	Code Grand Master	No	Yes/No
	<p>YES: Only a user with the Grand Master authority level can change all user codes, along with the time and date.</p> <p>NO: Grand Master as well as those with the Master authority level can change their own user codes and all codes of those with lower authority levels – in addition to allowing changing the time and date. Also enables those with User and Unbypass authority levels to change their own codes.</p>		
①②② ①④	Area	No	Yes/No
	<p>Changes the system operation to area instead of partition, which then changes only the operation of a common zone.</p> <p>YES: When selected, the following apply:</p> <ul style="list-style-type: none"> • A common zone will be armed after any partition is armed. • A common zone will be disarmed only when all partitions are disarmed. <p>NO: When selected, the following apply:</p> <ul style="list-style-type: none"> • A common zone will be armed only when all partitions are armed. • A common zone will be disarmed when any partition is disarmed. 		

Quick keys	Parameter	Default	Range
①②② 05	Global Follower	Yes	Yes/No
	<p>YES: Specifies that all zones (that are programmed to follow an Exit/Entry delay time) will follow the Exit/Entry delay time of any armed partition.</p> <p>NO: Specifies that all zones (that are programmed to follow an entry delay time) will follow the entry delay time of only the partitions to which they are assigned.</p>		
①②② 06	Summer/Winter	No	Yes/No
	<p>YES: The LightSYS Plus automatically sets its Time of Day clock one hour ahead in the spring (on the last Sunday in March) and one hour back in the Autumn (on the last Sunday in October).</p> <p>NO: No automatic time accommodation is made.</p>		
①②② 07	24-Hour Bypass	No	Yes/No
	<p>YES: It is possible for the user to bypass a 24-hour zone.</p> <p>NO: It is not possible for the user to bypass a 24-hour zone.</p>		
①②② 08	Technician Tamper	No	Yes/No
	<p>YES: It is necessary to enter the installer code to reset a tamper alarm (↖). Therefore, resetting a tamper alarm requires the intervention of the alarm company. However, the system can still be armed although the tamper indication is on.</p> <p>NO: Correcting the problem resets a tamper alarm, requiring no alarm company assistance.</p>		
①②② 09	Technician Reset	No	Yes/No
	<p>YES: It is necessary to enter the installer code to reset an alarmed partition after it has been disarmed. This requires the intervention of the alarm company technician/installer.</p> <p>Note</p> <p>Before the Ready LED (✓) can light, all zones within the partition must be secured.</p> <p>NO: Once an alarmed partition is reset the Ready LED lights when all zones are secured.</p>		

Quick keys	Parameter	Default	Range
①②② ①①	Installer Tamper	Yes	Yes/No
	<p>For above Grade 2, the system control bit “INSTALLER TAMPER” shall be defined as YES.</p> <p>YES: A Tamper event causes a lockout condition which can only be reset by the installer code or by anti-code.</p> <p>NO: A Tamper event does not cause a lockout condition</p>		
①②② ①①	Low Battery Arming	Yes	Yes/No
	<p>YES: Allows system arming when a low battery condition is detected (also in the power supply expansion module).</p> <p>NO: System arming is disabled when a low battery condition is detected.</p>		
①②② ①②	Bell 30/10	No	Yes/No
	<p>YES: Any internal sounders cease to sound for 10 seconds after each 30 seconds of operation.</p> <p>NO: Any internal sounders operate without interruption.</p>		
①②② ①③	Fire Temporal Pattern	No	Yes/No
	<p>YES: During a fire alarm, the sirens produce a pattern of three short bursts followed by a brief pause.</p> <p>NO: During a fire alarm, the flow of sounds produced by the siren is a pattern of two seconds ON, then two seconds OFF.</p>		
①②② ①④	IMQ Install	No	Yes/No
	<p>YES: Causes the following parameters to function as follows:</p> <ul style="list-style-type: none"> • Auto Arm Bypass: If there is an open zone during the auto arm process, the system will be armed, and a silent alarm will be activated (unless the open zone is closed). • A utility output defined as “Auto Arm Alarm” is activated. • A utility output defined as “Zone Loss Alarm” is activated • Guard User: If a Guard user disarms a partition, the system will be armed automatically after the predefined time period (see <i>Guard Delay page 82</i>). If there is an open zone during the arming process, the system will be armed, and an alarm will be sounded (unless the open zone is closed). <p>NO: Causes the following parameters to function as follows:</p> <ul style="list-style-type: none"> • Auto Arm Bypass: If the Auto Arm programming arms the system and there is an open zone during the auto arm, the system will bypass the open zones and arm the system. 		

Quick keys	Parameter	Default	Range
①②② ①⑤	Disable Incoming Calls	No	Yes/No
	<p>This parameter is used to disable all incoming calls trying to come in through the voice channel (GSM).</p> <p>YES: Incoming calls from voice channel are disabled.</p> <p>NO: Incoming calls from voice channel are enabled.</p> <p>Note Incoming data call via the GSM data channel is still enabled</p>		
①②② ①⑥	Disable Keypad When Auto Disarm Exists	No	Yes/No
	<p>YES: When a partition is armed manually or in auto arm mode, and an auto disarm time is defined, this parameter specifies that all the keypads that are masked to this partition will not function and that it will be impossible to disarm the relevant partition.</p> <p>Note The partition can be disarmed only by using the Configuration Software or the Auto Disarm function.</p> <p>NO: When a partition is armed manually or in Auto Arm mode, and an auto disarm time is defined, the relevant keypads will function normally.</p>		
①②② ①⑦	Buzzer Delay	No	Yes/No
	<p>YES: The keypad buzzer will be silent during the bell delay time.</p> <p>NO: The keypad buzzer will be audible immediately when a system alarm occurs.</p>		
①②② ①⑧	Speaker = Buzzer	No	Yes/No
	<p>YES: The internal sounder will follow the operation of any keypad's buzzer.</p> <p>NO: The internal sounder will follow the external sounder operation (and not the keypad's buzzer).</p>		
①②② ①⑨	Confirmation Speaker	No	Yes/No
	<p>YES: A confirmed alarm triggers the internal sounder.</p> <p>Note A confirmed alarm actually eliminates the buzzer delay time, causing the internal speaker to trigger immediately.</p> <p>NO: The internal speaker will trigger normally (at the end of bell delay time).</p>		
①②② ②①	Bell Confirmation	No	Yes/No

Quick keys	Parameter	Default	Range
	<p>YES: A confirmed alarm triggers the external bell.</p> <p>Note A confirmed alarm actually eliminates the bell delay time, causing the external alarm to start immediately.</p> <p>NO: The external bell will trigger normally (at the end of bell delay time).</p>		
① ② ② 2 1	Error Speaker Time Out	No	Yes/No
	<p>This option determines the duration of the alarm that is generated via the internal sounders (speakers) when the exit door is programmed as “Final Exit”, and it is not closed once the exit time expires (an “EXIT ERROR”).</p> <p>YES: The “EXIT ERROR” alarm in the internal speaker matches the alarm bell timeout setting.</p> <p>NO: The “EXIT ERROR” alarm in the internal speaker sounds continuously until user reset.</p>		
① ② ② 2 2	AC Trouble Arm	Yes	Yes/No
	<p>YES: The system can be armed with an AC trouble detected in the main panel, power supply module or the bus sounder.</p> <p>NO: The system cannot be armed with an AC trouble.</p>		
① ② ② 2 3	Strobe Arm	No	Yes/No
	<p>This option allows the strobe (internal or external activated by a utility output - Utility Output → Follow Partition → Strobe Trigger) to confirm the final arming of the system.</p> <p>YES: A ten-second strobe indication will occur after the system is armed.</p> <p>NO: There will be no strobe indication when the system is armed.</p>		
① ② ② 2 4	Final Night	Yes	Yes/No
	<p>This option determines the behavior of a final exit zone when the system is armed at partial (Stay) arming.</p> <p>YES: There is no need to open and close the door, if the door is closed, in order to arm the system in partial (Stay) arming. The zone behaves like a regular “EXIT(OP)” zone type.</p> <p>NO: There will be no change in the operation of a final exit zone in partial (Stay) arming.</p>		
① ② ② 2 5	Stay Strobe	No	Yes/No
	<p>YES: For partial (Stay) or group arming, a squawk indication will be made by the strobe activated by an output (Utility Output → Follow Partition</p>		

Quick keys	Parameter	Default	Range
	<p>→Strobe Trigger) at the end of the exit delay time. NO: For partial (Stay) arming or group arming, no indication will be made by the strobe at the end of the exit delay time.</p>		
①②② 2 6	Blank display	No	Yes/No
	<p>YES: Two minutes after the last keypad operation, the display will appear blank. After pressing any key, an "Enter Code" message will be displayed. The user should enter his code or pass his proximity tag. The display returns to the normal operation mode. Select this option for keypads that can be viewed from outside the protected area to disguise the system status. NO: The keypad display operates normally.</p>		
①②② 2 7	Disp.Sys.Lb	No	Yes/No
	<p>This option allows you to determine whether to display the system's label on the keypad display instead of the keypad's status. YES: The keypad displays system's label instead of Partition status. NO: The keypad does not display system's label.</p>		
①②② 2 8	PRES LOG N	No	Yes/No
	<p>YES: Presence will be recorded in the event log. No: Presence will not be recorded in the event log.</p>		
①②② 2 9	Wireless Lost as Tamper	No	Yes/No
	<p>Sets the behavior of the sound when a wireless loss zone is detected. YES: The sound can be activated as in a tamper condition. No: The sound can be activated as in a fault condition.</p>		

System → Controls → Communication

Quick keys	Parameter	Default	Range
①②③	Communication		
	This section refers to controls of the systems communication capabilities.		
①②③ 1	Monitoring Station Enable	Yes	Yes/No
	<p>YES: Enables communication with the monitoring station to report alarms, trouble, and supervisory events. NO: Disables communication with the monitoring station. Select NO for installations that are not monitored by a monitoring station.</p>		

Quick keys	Parameter	Default	Range
① ② ③ ②	Follow Me Enable	Yes	Yes/No
<p>YES: Enables Follow-Me communication. If both the monitoring station report and the FM report are defined, the system will first call the monitoring station phones and then the FM destinations.</p> <p>Note If FM is enabled and no voice module is installed then "beeps" will be sent instead of messages.</p> <p>NO: Disables Follow-Me communication.</p>			
① ② ③ ③	Configuration Software Enable	Yes	Yes/No
<p>YES: Enables communication between the alarm company (installer) and the LightSYS Plus main panel using the Configuration Software. This enables modifying an installation's configuration, obtaining status information, and issuing main panel commands, all from a remote location.</p> <p>NO: Disables communication, as detailed above.</p>			
① ② ③ ④	Cloud Enable	Yes	Yes/No
<p>YES: Enables communication between the LightSYS Plus system and the Cloud.</p> <p>NO: Disables Cloud communication.</p>			

System → Controls → EN 50131

Quick keys	Parameter	Default	Range
①②④	EN 50131		
	This section refers to controls that apply to EN 50131 approvals.		
①②④ ❶	Authorize Installer	No	Yes/No
	<p>This option limits the installer and sub-installer authorization to access the programming menu.</p> <p>YES: A Grand Master code is required to authorize the installer to enter the programming mode for one hour.</p> <p>NO: The installer does not need an authorization code.</p>		
①②④ ❷	Override Trouble	Yes	Yes/No
	<p>Specifies if the system/partition can be armed when there is a trouble in the system.</p> <p>YES: The system will arm even if there is a trouble in the system.</p> <p>NO: When the user starts the arming process and there is a system-trouble, the user must confirm that he is aware of all troubles before continuing with the arming process. The user needs to scroll the list of troubles. At the end of the list the following question will appear: "Override Trouble?" Toggle to Y (yes) and then press OK.</p>		
①②④ ❸	Restore Alarm	No	Yes/No
	<p>YES: The user must confirm that s/he is aware that alarm occurred in the system before rearming the system. The system/partition will be in "Not Ready" status until it confirms the alarm. The user needs to confirm the alarm by going to View → Alarm Memory</p> <p>NO: The user does not need to confirm the alarm before rearming the system.</p>		
①②④ ❹	Mandatory Event Log	No	Yes/No
	<p>YES: Only mandatory events (specified in the EN standard) will be displayed in the event log.</p> <p>NO: All the events will be displayed in the event log.</p>		

Quick keys	Parameter	Default	Range
① ② ④ ⑤	Restore Troubles	Yes	Yes/No
	<p>For above Grade 2, the system control bit “Restore Troubles” shall be defined as YES.</p> <p>YES: A System Trouble condition must be acknowledged by the user. NO: A System Trouble condition will reset automatically when clear.</p>		
① ② ④ ⑥	Exit Alarm	Yes	Yes/No
	<p>YES: A violated zone outside the exit route will generate an alarm during the exit time. A report to the monitoring station for arming the system is sent at the beginning of the arming procedure.</p> <p>NO: A violated zone outside the exit route that remains open at the end of the exit timer will cause a system fail-to-set condition. A report to the monitoring station is sent at the end of a successful arming procedure.</p>		
① ② ④ ⑦	Entry Alarm	No	Yes/No
	<p>This feature is used to reduce false alarm reports to the monitoring station.</p> <p>YES: The report to the monitoring station and the siren alarm will be delayed for 30 seconds or until the end of the predefined entry delay (the shorter time of the two) following a violation of a zone outside the entry route.</p> <p>NO: A violated zone outside the entry route will generate an alarm during the entry time and a report will be sent to the monitoring station.</p>		
① ② ④ ⑧	20 Minutes Signal	No	Yes/No
	<p>YES: Prior to arming the system, the system will check for zones that did not send a signal for more than 20 minutes. These zones will be regarded as not ready. A partition assigned with a not ready zone cannot be armed.</p> <p>NO: Prior to arming, the system will not check whether a zone did not send a signal for more than 20 minutes.</p>		
① ② ④ ⑨	Attenuation	No	Yes/No
	<p>YES: The LightSYS Plus device will be attenuated by 8dB during the communication test.</p> <p>NO: The LightSYS Plus device works in normal operation mode.</p>		

System → Controls → PD6662

Quick keys	Parameter	Default	Range
① ② ⑤	PD6662		
	If the PD6662 standard has been selected (see procedure on <i>page 104</i>), then the configurable controls for this standard (listed below) can be set as needed. NOTE: For the non-configurable "Hold-Up Alarm Confirmation" parameter, see <i>page 104</i> .		
① ② ⑤ ①	Bypass Exit/Entry	Yes	Yes/No
	YES: It is possible for the user to bypass an Exit/Entry zone. NO: An Exit/Entry zone cannot be bypassed.		
① ② ⑤ ②	Entry Disable	No	Yes/No
	YES: Alarm confirmation process will be disabled when entry time starts. NO: Alarm confirmation process will start when the entry time starts.		
① ② ⑤ ③	Route Disable	No	Yes/No
	YES: The panel disables the entry route zones (EX/EN, EX (OP)/EN, followers and Final Exit) from participating in the alarm confirmation process when the entry time starts.		
	Note Sequential confirmation can still be established from two confirmed zones, located off the entry route.		
	NO: The entry route zones will participate in the alarm confirmation process when the entry time starts.		
① ② ⑤ ④	Installer Confirmation	No	Yes/No
	YES: An installer confirmation is required in order to reset the system after a confirmed alarm. The system cannot be armed until an installer reset confirmation is performed. The reset can be done by entering the Anti Code or entering the installation mode or by performing an "Installer reset" from the keypad.		
	NO: Any means can be used to arm or disarm the system (keypad, remote phone operation etc.).		

Quick keys	Parameter	Default	Range
①②⑤ 5	Key Switch Lock	No	Yes/No
	<p>YES: Only a latched key switch zone can arm or disarm the system.</p> <p>Note</p> <p>When the system has more than 1 zone defined as latch key switch the arm / disarm operation will occur only after all these zones are armed or disarmed</p> <p>NO: Any means can be used to arm or disarm the system (keypad, remote phone operation, etc.).</p>		
①②⑤ 6	Entry Disarm	No	Yes/No
	<p>Determines if the system's disarming depends on the entry time.</p> <p>YES: Only a remote control can disarm the system during the entry time.</p> <p>Note</p> <p>System can't be disarmed with a remote control while the system is armed.</p> <p>NO: System can be disarmed during any time using any disarming device.</p>		
①②⑤ 7	Proximity Disarm All Partitions	Yes	Yes/No
	<p>Determines which partitions can be armed/disarmed using a Proximity tag.</p> <p>YES: The system arms/disarms all partitions that the proximity tag has authority of.</p> <p>NO: Enables you to select which partitions can be armed or disarmed depending on the authority of the partitions.</p>		

System → Controls → CP-01

Quick keys	Parameter	Default	Range
①②⑥	CP-01		
	<p>This section refers to controls that apply to comply with SIA CP 01.</p>		
①②⑥ 1	Exit Restart	No	Yes/No
	<p>This parameter is used to define if an exit time shall restart one additional time while an entry/exit zone is tripped twice during exit time.</p> <p>YES: Exit time will restart for one time only when an entry/exit zone is tripped during exit time.</p> <p>NO: Exit time will not be affected if an entry/exit zone is tripped during exit time.</p>		
①②⑥ 2	Auto Stay	No	Yes/No
	<p>This parameter is used to define the system's arming mode when using a keypad and no exit/entry zone is tripped during exit mode.</p>		

Quick keys	Parameter	Default	Range
	<p>YES: If no exit/entry zone is tripped during exit time the system will be armed in partial (Stay) arming mode.</p> <p>NO: If no exit/entry zone is tripped during exit time the system will be armed in full (Away) arming mode.</p>		

System → Controls → Device

Quick keys	Parameter	Default	Range
①②⑦	Device		
	This section refers to controls that apply to bus devices		
①②⑦ ❶	Anti Mask = Tamper	No	Yes/No
	<p>Used to determine the operation of anti-masking detection in a bus zone.</p> <p>YES: Anti mask violation will activate tamper alarm.</p> <p>NO: Anti mask violation will be regarded as trouble event.</p>		
①②⑦ ❷	Proximity Anti Mask = Tamper	No	Yes/No
	<p>Used to determine the operation of the proximity anti masking detection indicated by the microwave channel in the WatchOUT DT detector.</p> <p>YES: Proximity anti mask detection will activate the tamper alarm.</p> <p>NO: Proximity anti mask detection will be regarded as a fault event.</p> <p>Notes</p> <ul style="list-style-type: none"> • The Proximity Anti Mask operates for approximately 2.2 seconds when the detector is approached in close proximity. • Ensure that Proximity Anti Mask has been enabled when configuring the WatchOUT DT bus zone parameters. 		
①②⑦ ❸	Audible Proximity Tamper	No	Yes/No
	<p>This parameter relates to the bus siren.</p> <p>YES: A proximity anti approach violation will activate the siren.</p> <p>NO: A proximity anti approach violation will not activate the siren and will be regarded as trouble by the system.</p>		
①②⑦ ❹	Siren Auxiliary = Tamper	No	Yes/No
	<p>This parameter relates to the bus siren.</p> <p>YES: A siren auxiliary trouble will be regarded as tamper alarm by the system.</p> <p>NO: A siren auxiliary trouble will be regarded as trouble by the system.</p>		

Quick keys	Parameter	Default	Range
①②⑦⑤	Siren Pre-Alarm	No	Yes/No
	<p>Specifies if the system will send a pre-alarm message to the siren while an entry delay starts.</p> <p>YES: The system sends a pre-alarm signal to the siren at the beginning of the entry delay. If the siren does not receive a cancellation signal from the system at the end of the entry time, the siren goes into alarm.</p> <p>NO: Pre-Alarm disabled.</p>		
①②⑦⑥	RF Wake-Up	No	Yes/No
	<p>Toggle between Y (yes) and N (no) to define whether the system can wake up the 2-way wireless Slim keypad during exit/entry times, or when failing to arm the system.</p> <p>YES: The system wakes up the keypad.</p> <p>NO: The system cannot wake up a 2-way keypad (this saves battery life).</p>		
①②⑦⑦	Keyfob Instant Arm	No	Yes/No
	<p>YES: Away arming from any 2-way remote control will be instant.</p> <p>NO: Away arming from any 2-way remote control will be delayed, following exit delay 1.</p>		
①②⑦⑧	Keyfob Instant Stay	No	Yes/No
	<p>YES: Stay arming from any 2-way remote control will be instant.</p> <p>NO: Stay arming from any 2-way remote control will be delayed, following exit delay 1.</p>		
①②⑦⑨	Disarm using Code	No	Yes/No
	<p>Defines if a PIN code is required to perform the disarm operation while using any of the 2-way remote controls.</p>		

①③ Labels

Define global system and partition labels.

System → Labels

Quick keys	Parameter	Default	Range
①③①	System	Security System	Any 16 characters
	Edit the global system label		
①③②	Partitions (01-32)	Partition 01 – 32	Any 16 characters
	Edit the label of the partitions		

①④ Sounds

Define the following system sound parameters:

- **Tamper**
- **Speaker Volume**

System → Sounds → Tamper

Quick keys	Parameter	Default	Range
①④①	Tamper Sound		
	Sets the sound(s) produced by a tamper violation of a keypad and/or an expansion module, as follows: ① Silent – Produces no sound ② Bell Only (external siren) ③ Buzzer Only (keypad piezo) ④ Bell + Buzzer		
①④①①	During Disarm	Buzzer	1–4
	Sets the sound produced by tamper violation while the system is disarmed.		
①④①②	During Arm	Bell only	1–4
	Sets the sound produced by tamper violation while the system is armed.		

System → Sounds → Speaker Volume

Quick keys	Parameter	Default	Range
①④②	Speaker Volume		

Quick keys	Parameter	Default	Range
	Sets the volume of internal sounder (speaker) connected to the Bells/LS (+ and -- terminals) according to different system modes. Volume range is between 0 (silent) and 9 (maximum). After changing the volume, sound will be emitted by the internal sounder to enable evaluation of the selected volume level.		
①④② ❶	Trouble	9	0–9
	Determines the volume of the internal sounder beeps while there is trouble in the system.		
①④② ❷	Chime	9	0–9
	Determines volume of internal sounder chime sound. The Chime sound is used as an audible indication to a zone violation while system is disarmed.		
①④② ❸	Exit/Entry	9	0–9
	Determines the volume of the beeps sounded from the internal sounder during the Exit/Entry times.		
①④② ❹	Alarm	9	0–9
	Determines the volume of the beeps sounded from the internal sounder during an alarm.		
①④② ❺	Squawk	9	0–9
	Determines the volume of the squawk sounded from the internal sounder during an alarm.		

①⑤ Settings

Set the System Settings parameters as needed.

System → Settings

Quick keys	Parameter	Default	Range
①⑤ ❶	Siren Mode		
	Select to set either the bell or electronic siren with a built-in siren driver (Bell), a loudspeaker without a built-in sound driver (Loudspeaker) , or None.		
①⑤ ❷	Default Panel		
	Restores programming options to factory defaults.		
①⑤ ❸	Erase Wireless		

Quick keys	Parameter	Default	Range
	Erases wireless devices without changing the system current programmed parameters. Select the wireless device to be erased.		
	<p>Note This entry appears only if a wireless device is allocated in the system.</p>		

Quick keys	Parameter	Default	Range
① ⑤ ④	Standard		
	Sets the panel programming options in compliance with the selected standard.		
① ⑤ ④ ①	EN 50131 (G2)		
	For EN 50131 (G2), see page 95.		
① ⑤ ④ ②	PD6662		
	<p>By selecting this standard:</p> <ul style="list-style-type: none"> • Configurable parameters applicable for this standard can be set as needed (see <i>page 97</i>). • Parameters for the HU (Hold-Up) Alarm Confirmation are automatically set, and any respective outputs are activated accordingly. <p>NOTE: See below for HU Alarm Confirmation description and the required action for non-reinstated HU devices.</p> <p>HU Alarm Confirmation Description:</p> <p>Part of the BS 8243:2010 standard, "HU alarm confirmation" automatically sends a "confirmed" alarm notification to the monitoring station when at least 2 separate, sequential HU (panic) alarms occur during the "HU confirmation time period" – which is fixed at 8 hours.</p> <p>The alarms must be triggered from different HU devices – for example, 2 panic alarms that are each triggered from a different keypad, or that are triggered from 1 keypad and 1 keyfob (the keyfob must be installer-configured to be used for panic alarms).</p> <p>At the expiration of the HU confirmation time period, if only one HU (panic) alarm has occurred – but not the second one that is required for confirmation - then the system is automatically reinstated (restored to a normal state).</p> <p>At the end of the HU confirmation time period, all non-reinstated HU devices are automatically bypassed – which will appear in the system's event log, the monitoring station will be notified, and there will be an indication at the panel to notify the user.</p> <p><u>IMPORTANT: As these non-reinstated (now bypassed) devices are still in an alarm state, perform a system restore per the system's definition.</u></p>		

Quick keys	Parameter	Default	Range
① ⑤ ④ 3	CP01		
	For CP01, see page 98		
① ⑤ ④ 4	EN 50131 (G3)		
	For EN 50131 (G3), see page 95		
① ⑤ 5	Customer		
	Sets the panel programming options in compliance with the selected customer code. Each customer has its predefined parameters.		
	<p>Note</p> Selecting a customer that is different than the one in use will automatically default the panel.		
① ⑤ 6	Language		
	Sets the system language (e-mail, SMS and keypad interface language)		
	<ul style="list-style-type: none"> ① Text - Change the interface keypad language ② Voice - Change the voice language (this option is only available if a voice module is assigned to the system) 		
① ⑤ 7	Partition Qty	8	08—32
	Set the Partition Quantity parameter to define the number of partitions allocated to the system (up to 32).		
	Press OK to view the number of partitions. Default is 08 (meaning up to 8).		
	To change number of partitions, enter the number of partitions over the number that currently displays.		
① ⑤ 8	Bypass tamper	Yes/No	
	This option allows you to bypass the bell/box.		
	<ul style="list-style-type: none"> 1. Bell tamper (default=No) 2. Box tamper (default=No) 		

①⑥ Automatic Clock

Set the Automatic Clock parameters to retrieve automatic time updates (NTP or Daytime) through IP or GPRS/3G/4G.

System → Automatic Clock

Quick keys	Parameter	Default	Range
①⑥①	Server	Daytime	
	Select the internet time protocol: ① NTP (Network Time Protocol) ② DAYTIME		
①⑥②	Host	99.150.184.201	
	The IP address or server name.		
①⑥③	Port	00013	
	The NTP server port.		
①⑥④	Time Zone (GMT)		
	Scroll through the available selections (GMT-12:00 - GMT+13:00).		

①⑦ Service Information

Enter the service information details of the monitoring station.

System → Service Information

Quick keys	Parameter	Default	Range
①⑦①	Name	Any 16 characters	
	Enables you to insert and/or edit the name of the monitoring station from where service may be obtained.		
①⑦②	Phone	Any 16 characters	
	Enables you to insert and/or edit the service phone number.		

①⑧ Firmware Update

Set parameters when updating the system firmware.

Note

The firmware update menu option series is visible only if the IP or GSM module is installed.

System → Firmware Update

Quick keys	Parameter	Default	Range
① ⑧ ①	Server IP	firmware.riscogroup.com	
	Enter the IP address of the router/gateway where the upgrade file is located.		
① ⑧ ②	Server Port	80	
	Enter the port on the router/gateway where the upgrade file is located		
① ⑧ ③	File Name	CMD.TXT (case sensitive)	
	Enter the firmware update file name. NOTE: Please contact Customer Support services for the file name parameters		
① ⑧ ④	Download File		
	Select the communication path for the upgrade. ① Via IP ② Via GPRS/3G/4G		

② Zones

Configure the following "**basic**" zone parameters for all types of zones. Each zone can be defined as a wired zone, a wireless zones or a bus zone. The attributes for each zone vary according to the zone's type. The following sub-menus are available:

- **Parameters**
- **Testing**
- **Cross Zones**
- **Alarm Confirm**

②① Parameters

Configure the **basic parameters** for all zone types by the following method(s):

- **One-By-One:** Define all the relevant parameters for one zone at a time
- **By Category:** Define a specific parameter accordingly for multiple zones (as you go from one zone to another, scrolling through all zones in the system)
- **Resistance:** If required, define the zone's termination resistance

Note

Advanced parameters are also available for bus zones and wireless zones – see *Step 6: Advanced Zone Configuration for Bus Zones and Wireless Zones, page 69.*

One-By-One

Zones → Parameters → One-By-One

Quick keys	Parameter	Default	Range
②①①	One-By-One		
See <i>Defining Zone Parameters using the "One-By-One" Option, page 67.</i>			

By Category

Zones → Parameters → By Category

Quick keys	Parameter	Default	Range
②①②	By Category		
See <i>Defining Zone Parameters using the "By Category" Option, page 68</i> for an explanation, and see below for defining the parameters:			
<ul style="list-style-type: none"> ① Label ② Zone Partition (and Group) ③ Type ④ Sound ⑤ Termination ⑥ Loop Response ⑦ Advanced 			

Zones → Parameters → By Category → Label

Quick keys	Parameter	Default	Range
②①② ①	Label		
The label identifies the zone in the system. Up to 16 characters. Type a descriptive label over the default "ZONE"			

Zones → Parameters → By Category → Zone Partition (and Group)

Quick keys	Parameter	Default	Range
②①② ② ZZZ	Zone Partition		
<ol style="list-style-type: none"> 1. Use scroll keys and enter a zone number (ZZZ), then press OK. If a zone displays with "(--:-- --:-- --:--)" it means that zone has not yet been allocated. 2. After you have selected an allocated zone, enter the number of the partition and then press OK. If you had defined more than 8 (default) partitions to be available in the system, you will need to scroll to get to the partition that you want the zone to be in. As there are 32 partitions maximum, the available partitions are in blocks of partitions. When you scroll to the appropriate block, enter the partition number; it will display as P=## (whereas ## is the partition). 3. Press OK. 			
②①② ② ZZZ ABCD	Group		
<p>A group is a specific area (zone) that can be armed within a specific partition. There are up to 4 groups possible per partition (groups A–D).</p> <ol style="list-style-type: none"> 1. Select zone partition (see procedure directly above). 2. For each applicable group letter (A–D), toggle to select it (Y), or to clear it. 3. Press OK. 			

Zones → Parameters → By Category → Type

Quick keys	Parameter	Default	Range
②①②③	Type		
<p>The Zone Type menu contains parameters that enable you to program the zone type for any zone.</p> <p>1) Select the zone (ZZZ) and then press OK.</p> <p>2) Then scroll to select the zone type (35 types – see below) and press OK.</p> <p>Note Zones for partial arming (“Stay” arming) must be defined as Interior type. Available options:</p> <p> ①⑦: Interior+Exit/Entry 1, ①①: Interior +Entry follower ①⑧: Interior+Exit/Entry 2, ①②: Interior+Instant ①⑨: Interior+Exit(OP)/Entry </p>			
Quick keys	Parameter	Default	Range
②①②③ZZZ ①①	Not Used		
Disables a zone. All unused zones should be given this designation			
②①②③ZZZ ①①	Exit/Entry 1		
<p>Used for Exit/Entry doors. Violated Exit/Entry zones do not cause an intrusion alarm during the Exit/Entry delay. If the zone is not secured by the end the delay expires it will trigger an intrusion alarm.</p> <p>To start an arming process, this zone should be secured. When system is armed, this zone starts the entry delay time (see ①①①).</p>			
②①②③ZZZ ①②	Exit/Entry 2		Arm/Stay
Same as above, except that the Exit/Entry 2 time period applies			
②①②③ZZZ ①③	Exit (OP)/Entry 1		
<p>Used for an exit/entry door, open during the armed period.</p> <p>This zone behaves as described in the Exit/Entry 1 parameter, shown above, except that, if faulted when the system is being armed, it does not prevent arming.</p> <p>To avoid an intrusion alarm, it must be secured before the expiration of the Exit Delay period.</p>			

Quick keys	Parameter	Default	Range
②①②③ZZZ ①④	Exit (OP)/Entry 2		
Same as above, except that the Exit (Op)/Entry 2 time period applies.			
②①②③ZZZ ①⑤	Entry Follower		
Usually assigned to motion detectors and to interior doors protecting the area between the entry door and the keypad. This zone(s) causes an immediate intrusion alarm when violated unless an Exit/Entry zone was violated first. In this case, Entry Follower zone(s) will remain bypassed until the end of the Entry Delay period.			
②①②③ZZZ ①⑥	Instant		
Usually intended for non-exit/entry doors, window protection, shock detection, and motion detectors. Causes an immediate intrusion alarm if violated after the system is armed or during the Exit Delay time period. When Auto Arm and Pre-Warning are defined, the instant zone will be armed at the end of the Pre-Warning time period.			
②①②③ZZZ ①⑦	I+ Exit/Entry 1 (Interior+ Exit/Entry 1)		
Used for Exit/Entry doors, as follows: <ul style="list-style-type: none"> • If the system is armed in the Away (full) arming mode, the zone(s) provide a delay (specified by Exit/Entry 1) allowing entry and exit to and-from the armed premises. • If the system is armed in the Stay mode, the zone is bypassed. <p>Important</p> <p>For greater security when arming in the partial (Stay) arming mode, it is possible to eliminate the Entry Delay period associated with any zone(s), classified as Exit/Entry Delay 1 by pressing the  key twice, one after another. In effect, this makes it an instantly-armed zone.</p>			
②①②③ZZZ ①⑧	I + Exit/Entry 2 (Interior + Exit/Entry 2)		
Same as the I+Exit/Entry 1 parameter, described above, but the Exit/Entry 2 time period is applicable.			

Quick keys	Parameter	Default	Range
②①②③ZZZ ①⑨	I + Exit(OP)/Entry 1 Interior + Exit(OP)/Entry 1)		
	<p>Used for an exit/entry door that, for convenience, may be kept open when the system is being armed, as follows:</p> <ul style="list-style-type: none"> In full (Away) arming mode behaves as an Exit (Op)/Entry 1 zone (see ②①ZZZ①③ above). In partial (Stay) arming mode, the zone will be bypassed. 		
②①②③ZZZ ①①①	I + Exit(OP)/Entry 2 Interior + Exit(OP)/Entry 2)		
	<p>Used for an exit/entry door that, for convenience, may be kept open when the system is being armed, as follows:</p> <ul style="list-style-type: none"> In full (Away) arming mode behaves as an Exit (Op)/Entry 2 zone (see ②①ZZZ①④ above). In partial (Stay) arming mode, the zone will be bypassed. 		
②①②③ZZZ ①①①	I+ Entry Follow (Interior + Entry Follower)		
	<p>Generally used for motion detectors and/or interior doors (for example, foyer), which would have to be violated after entry in order to disarm the system, as follows:</p> <ul style="list-style-type: none"> In full (Away) arming mode behaves as an Entry Follower zone. (see ②①ZZZ①⑤ above). In partial (Stay) arming mode, the zone will be bypassed. 		
②①②③ZZZ ①①②	I + Instant (Interior + Instant)		
	<p>Usually intended for non-exit/entry doors, window protection, shock detection and motion detectors.</p> <ul style="list-style-type: none"> In full (Away) arming mode behaves as an intruder (instant) zone. In partial (Stay) arming mode, the zone is bypassed. 		
②①②③ZZZ ①①③	UO Trigger		
	<p>For a device or zone, which if violated at any time triggers a previously programmed utility output, and can activate an external indicator, relay, appliance, and so on.</p>		

Quick keys	Parameter	Default	Range
②①②③ZZZ ①④	Day		Arm
	<p>Usually assigned to an infrequently used door, such as an emergency door or a movable skylight. Used to alert the system user if a violation occurs during the unset period (fault by day; Intruder at night), as follows:</p> <ul style="list-style-type: none"> • With the system partially or fully armed (Stay or Away), the zone acts as an intruder zone. A violation of this zone after the system is armed or during the exit delay time period causes an immediate intrusion alarm. • With the system disarmed, a violation of this zone attempts to alert the user by causing the POWER/🔌 indicator on all keypads to flash rapidly. This directs the user to view the system's trouble indications. • Optionally, such a violation can be reported to the monitoring station as a zone trouble. See <i>Appendix E: Report Codes</i> → <i>Miscellaneous</i> (page.250). 		
②①②③ZZZ ①⑤	24 Hours		
	<p>Usually assigned to protect non-movable glass, fixed skylights, and cabinets (possibly) for shock detection systems.</p> <p>A violation of such a zone causes an instant intrusion alarm, regardless of the system's state</p>		
②①②③ZZZ ①⑥	Fire		
	<p>For smoke or other types of fire detectors. This option can also be used for manually-triggered panic buttons or pull stations (if permitted), as follows:</p> <ul style="list-style-type: none"> • If violated, it causes an immediate fire alarm, and the Fire/🔥 indicator is lit (steady). • A fault in the wiring (wire open) to any fire zone causes a Fire Trouble signal (a rapid flashing of the keypads' Fire / 🔥 indicator). A short in the wires will cause an immediate alarm. 		
②①②③ZZZ ①⑦	Panic		
	<p>Used for external panic buttons and wireless panic transmitters.</p> <p>If violated, an immediate panic alarm is sounded (if the zone sound is not defined as silent or audible panic system control is enabled), regardless of the system's state, and a panic report is sent to the monitoring station. An alarm display will not appear on the keypads. If violated, an immediate panic alarm is sounded, regardless of the system's state.</p>		

Quick keys	Parameter	Default	Range
②①②③ZZZ ①①③	Special		
	<p>For external auxiliary emergency alert buttons and wireless auxiliary emergency transmitters.</p> <p>If violated, an immediate auxiliary emergency alarm is sounded, regardless of the system's state and a report is sent to the monitoring station.</p>		
②①②③ZZZ ①①⑨	Key Switch		
	<p>Used to arm/disarm the system.</p> <p>Connects an external momentary action key switch to any zone terminals given this designation.</p>		
②①②③ZZZ ①②①	Final Exit		
	<p>Zones of this type must be the last detector to be activated on exit or the first detector to be activated on entry. When arming the system, the related partition arms 10 seconds after this zone is closed, or opened and then closed. After triggered once the zone acts as an exit (open)/entry 1 zone.</p>		
②①②③ZZZ ①②①	Latch Key Switch		
	<p>Connect an external SPST latched (non-momentary) key switch to any zone terminals given this designation and operate the keyswitch, as follows:</p> <ul style="list-style-type: none"> • After arming one or more partitions using the key switch and then disarming using the keypad, the related partitions will be disarmed. In order to arm the partition using the key switch again, turn the key to the disarm position and then to the arm position. • If a key switch latch is assigned to more than one partition and one of the partitions is armed by using the keypad (the key switch stays in the disarm position), then: <ul style="list-style-type: none"> ○ When changing the position of the key switch to the arm position, all the disarmed partitions, which belong to this key switch, will be armed. ○ When turning the key switch to the disarm position, all the partitions will be disarmed. 		

Quick keys	Parameter	Default	Range
②①②③ZZZ ①②②	Entry Follower + Stay		All
	Assigned to motion detectors and to interior doors protecting the area between the entry door and the keypad, as follows: <ul style="list-style-type: none"> In partial (Stay) arming mode, a zone(s) given this designation behaves like an Exit/Entry zone and is subject to the Entry and Exit Delay time periods specified under Exit/Entry Delay 1. See <i>Exit/Entry Delay 1</i>, above (②①②③ZZZ①①) and ①①①①. In full (Away) arming mode, a zone(s) given this designation behaves like an Entry Follower Zone and causes an immediate intrusion alarm when violated unless an Exit/Entry zone was violated first. If so, an Entry Follower + Stay zone(s) remains bypassed until the end of the Entry Delay period. 		
②①②③ZZZ ①②③	Key Switch Delay		
	Used to apply the Exit/Entry Delay 1 parameter to the momentary key switch operation. See <i>Exit/Entry Delay 1</i> , above (②①②③ZZZ①①) and ①①①①.		
②①②③ZZZ ①②④	Latch Key Switch Delay		
	Used to apply the Exit/Entry Delay 1 parameter to the latched key switch operation. See <i>Exit/Entry Delay 1</i> , above (②①②③ZZZ①①) and ①①①①.		
②①②③ZZZ ①②⑤	Tamper		
	For tamper detection. This zone operates the same as 24 hours zone, but it has a special reporting code. <p>Note</p> For this zone type the zone sound is determined according to the Tamper Sound defined under 1) System → 4) Sound → 1) Tamper		
②①②③ZZZ ①②⑥	Technical		
	This zone operates the same as 24 hours zone, its report code should be manually set according to the relevant detector connected to the zone.		

Quick keys	Parameter	Default	Range
②①②③ZZZ 027	Water		
	For flood or other types of water detectors. This zone operates the same as 24 hours zone, but it has a special flood report code.		
②①②③ZZZ 028	Gas		
	For Gas (natural gas) leak detector. This zone operates the same as 24 hours zone, but it has a special gas report code.		
②①②③ZZZ 029	CO		
	For CO (Carbon Monoxide) gas detectors. This zone operates the same as 24 hours zone, but it has a special CO report code.		
②①②③ZZZ 030	Exit Term		
	<p>This zone is normally connected to a push button outside the protected premises, which can be used to finally arm the system or area.</p> <p>The exit time is infinite and the related partition is not armed until this zone is triggered. When triggered, the exit time resets to 10 seconds. Use this zone to arm the system. It cannot trigger an alarm.</p> <p>If the partition is not secured when the exit time expires, the system stays disarmed and the keypad displays: "Fail to Arm". No "Fail to Arm" report is sent to the Monitoring Station.</p>		
②①②③ZZZ 031	High Temperature		
	For detector temperature (hot or cold). This zone operates the same as 24 hours zone, but it has a special report code.		
②①②③ZZZ 032	Low Temperature		
	For detector temperature (hot or cold). This zone operates the same as 24 hours zone, but it has a special report code.		
②①②③ZZZ 033	Key Box		
	<p>This zone is mainly used in Scandinavia. Triggering this zone will be recorded in the event log. It can also be reported to the monitoring station. No alarm is triggered.</p> <p>When using this zone you should connect the alarm wiring of this zone</p>		

Quick keys	Parameter	Default	Range
	(usually the auxiliary contact of a door) to an external key box and the tamper wiring to the housing switch.		
②①②③ZZZ ①③④	Key Switch Arm		
	<p>This zone is used by financial institutions such as cash distribution centers and banks to control the arming of the vault door or treasury department entrance.</p> <p>Use this zone for instant arming of the partition in which the zone is allocated. This zone cannot perform disarming operation.</p>		
②①②③ZZZ ①③⑤	Key Switch Delayed Arm		
	Same as the Key Switch Arm type (see above), but the arming will be delayed following exit delayed time.		

Zones → Parameters → By Category → Sound

Quick keys	Parameter	Default	Range
②①②④	Sound		
	<p>This menu enables you to program the sound produced when a systems zone triggers and alarm. Reporting to the central station is not affected by the option of this menu.</p> <p>The following sound can be selected:</p> <ul style="list-style-type: none"> • Silent: Produces no sound • Bell Only: Activates the bell sounders for the duration of the Bell Timeout period, or until a User Code is entered • Buzzer Only: Activates each keypad's internal piezo buzzer • Bell + Buzzer: Activates the bell sounders and the keypads' buzzers simultaneously • Door Chime: The Door Chime parameter is used as an audible sounder to indicate the violation of a zone(s), as follows: <ul style="list-style-type: none"> ○ If the system is disarmed, the system's keypad buzzers make three momentary sounds whenever the zone is violated. ○ If the system is armed, only the bell sounders produce the alarm. <p>A different sound can be defined according to the system status as follows</p>		
②①②④ ①	At Arm		

Quick keys	Parameter	Default	Range
	Set the sound produced when a system's zone triggers an alarm while the system is fully (Away) armed.		
②①②④ ②	At Stay		
	Set the sound produced when a system's zone triggers an alarm while the system is partially (Stay) armed.		
②①②④ ③	At Disarm		
	Set the sound produced when a system's zone triggers an alarm while the system is disarmed.		

Zones → Parameters → By Category → Termination

Quick keys	Parameter	Default	Range
②①② ⑤	Termination		
	<p>The Termination menu enables you to program the connection type used for each of the system's zones. The actual (physical) termination for each zone must comply with that selected in the zone termination menu.</p> <ol style="list-style-type: none"> 1. Select the zone (ZZZ) and then press OK. 2. Scroll to select the zone termination resistance type (see below), and press OK. 		
②①②⑤ ①①	N/C		
	Uses normally-closed contacts and no terminating End-of-Line Resistance		
②①②⑤ ①②	EOL		
	Uses normally-closed (NC) contacts in a zone terminated by End-of-Line Resistance.		
②①②⑤ ①③	DEOL		
	Uses normally-closed (NC) contacts in a zone terminated by Double End-of-Line Resistance to distinguish between alarm and tamper conditions on the same zone.		
②①②⑤ ①④	N/O		
	Uses normally-open contacts and no terminating End-of-Line Resistance.		

Quick keys	Parameter	Default	Range
②①②⑤①⑤	TEOL		
<p>Uses normally-closed (NC) contacts in a zone terminated by Triple End-of-Line Resistance to distinguish between alarm, tamper and anti-mask conditions on the same zone.</p>			

Zones → Parameters → By Category → Loop Response

Quick keys	Parameter	Default	Range
②①②⑥	Loop Response		
<p>The Loop Response menu enables you to set the different times for which a zone violation must exist before the zone will trigger an alarm condition.</p> <ol style="list-style-type: none"> Select the zone (ZZZ) and then press OK. Then scroll to select a loop response type: <ul style="list-style-type: none"> ① Normal: 400 ms (milliseconds). ② Long: 1 second ③ Fast: 10 ms (milliseconds). ④ Extra Fast: 1 ms (millisecond). This loop response is usually used for shutters or other devices that require very quick responses ⑤ 0.5 HOURS ⑥ 1 HOURS ⑦ 1.5 HOURS ⑧ 2 HOURS ⑨ 2.5 HOURS ①① 3 HOURS ①① 3.5 HOURS ①② 4 HOURS Press OK. 			

Zones → Parameters → By Category → Advanced

The following Advanced zone parameters are available for configuration:

- **Advanced**
- **Bus Zone Parameters**
- **Wireless Zone Configuration**

Quick keys	Parameter	Default	Range
②①②⑦	Advanced		
②①②⑦①	Forced arming		
	<p>This option enables or disables the use of forced arming for each of the system's zones, as follows:</p> <ul style="list-style-type: none"> • If forced arming is enabled for a particular zone, it allows the system to be armed even though this zone is faulty. • When a zone(s) enabled for forced arming is faulted, the red LED blinks during disarm period. • After arming, all zones enabled for forced arming are bypassed at the end of the exit delay time period (see ①①①① page 80). • If a faulted zone (one enabled for force arming) is secured during the armed period, it will no longer be bypassed and will be included among the system's armed zones. <ol style="list-style-type: none"> 1. Select the zone (ZZZ) and then press OK. 2. Then scroll to select either DISABLE or ENABLE. 3. Press OK. 		
②①②⑦②	Pulse Counter	01	01 – 15
	<p>Specifies that the zone will count the number of open and close pulses received. If the zone exceeds the predefined number of pulses, the zone will be tripped and act according to its type definition. After a 25-second timeout the pulse counter is restarted. The pulse length is the currently defined loop response time period (see Zones → Loop Response, page 119).</p> <ul style="list-style-type: none"> • Select the pulse count, and then press OK. 		
②①②⑦③	Abort Alarm		
	<p>This parameter defines whether a zone alarm report to the monitoring station will be immediate or delayed:</p> <ol style="list-style-type: none"> 1. Select the zone (ZZZ) and then press OK. 2. Then scroll to select either: 		

Quick keys	Parameter	Default	Range
	<p>❶ ENABLE: A report to the MS will be delayed according to the Abort Time Delay parameter ⑤②⑥② (Communication → MS → MS Times → Abort Alarm).</p> <p>❷ DISABLE: A report to the MS will be sent immediately</p> <p>3.. Press OK.</p>		

Zones → Parameters → By Category → Advanced → Bus Zone Parameters

Quick keys	Parameter	Default	Range
②①②⑦ ❹	Bus Zone Parameters		
<p>The Bus Zone Parameters menu contains parameters that enable you to program the special parameters of a bus zone. The options are determined according to the bus detector type:</p> <ol style="list-style-type: none"> 1. Select the zone number (ZZZ) and then press OK. 2. Scroll to select from the available BZ parameters to configure (parameters are device-specific – see device list below). 3. Set parameters for the following RISCO bus detectors (see the following sections as well as the packaged instructions for details), and when finished, press OK. <p>RISCO Bus Detectors:</p> <ul style="list-style-type: none"> • Lunar Grade 3: A dual technology ceiling detector with a mounting height of up to 8.6m (28ft) that incorporates Anti-Cloak™ Technology (ACT). • WatchOUT DT: A dual technology outdoor detector with signal processing based on two Passive Infrared (PRI) channels and two microwave (MW) channels. • WatchOUT PIR: An outdoor detector with signal processing based on two Passive Infrared correlated channels • WatchIN DT Grade 3: A dual technology Grade 3 industrial detector with signal processing based on two Passive Infrared channels and two microwave channels. • iWISE QUAD Grade 2: A motion detector incorporating Quad PIR technology • iWISE QUAD Grade 3: A motion detector incorporating Anti-Mask and Quad PIR technologies. • iWISE DT Grade 3: A motion detector incorporating both Anti-Mask and Anti-Cloak™ Technologies (ACT). It adheres to environmentally friendly guidelines and is available in 15m and 25m models. 			

Quick keys	Parameter	Default	Range
	<ul style="list-style-type: none"> • BWare DT Grade 3 A dual technology Grade 3 industrial detector with signal processing based on two Passive Infrared channels and two K-band microwave channels. • BWare QUAD Grade 3 A motion detector incorporating Anti-Mask and Quad PIR technologies. • Seismic: A detector that monitors the vibration and temperature of a specific surface and will react to all known types of intruder attacks. 		
Quick keys	Parameter	Default	Range
②①②⑦ ⑥	Presence	Disable	Enable/Disable
	<p>Zone=001 (0:E00:01)</p> <p>A zone that is set as Presence will send a push notification to the end-user when triggered during disarm state.</p> <p>NOTE: Presence is applicable to all wired and wireless detectors except for Beyond/PIR Camera Detectors.</p> <p>① Enable or ② Disable sending a push notification to the end-user.</p>		
	<p>Notes</p> <ul style="list-style-type: none"> • The Presence push notifications option must also be selected in the RISCO Cloud for the notifications to be sent to the end-user's smartphone. • The Presence zone can also be muted via the RISCO Cloud. 		

Bus Zone: OPR12 (WatchOUT PIR)

Quick keys	Parameter	Default	Range
②①②⑦④ZZZ①	LEDS	3 LEDS	
	Defines the LEDS operation mode. ① OFF - Disables the LEDS operation. ② RED ONLY - Only the Red LED will operate. This option is highly recommended to avoid the possibility that a burglar will “learn” the detector behavior. ③ 3 LEDS - All 3 LEDS will operate.		
②①②⑦④ ZZZ ②	PIR Sensitivity	Normal	
	Defines the PIR sensitivity of the detector. ① LOW ② MEDIUM ③ NORMAL ④ HIGH		
②①②⑦④ ZZZ ③	Lens Type	Wide Angle	
	Defines the actual lens of the detector. ① WIDE ANGLE ② BARRIER / LONG RANGE		
②①②⑦④ ZZZ ④	Auxiliary Relay Mode	OFF	
	Defines the operation of the auxiliary relay of the detector. ① OFF - Auxiliary relay is disabled ② 24 Hours - The auxiliary relay will always follow an alarm ③ NIGHT ONLY - The auxiliary relay output will follow an alarm condition only during night time.		
②①②⑦④ ZZZ ⑤	Auxiliary Relay Time	2.2 Seconds	2.2—480 seconds
	Defines the time duration that the auxiliary relay is activated. ① 2.2 SECONDS ② 2 MINUTES ③ 4 MINUTES ④ 8 MINUTES		

Bus Zone: iWISE DT Grade 2

Quick Keys	Parameter	Default	Range
②①②⑦④ ZZZ ①	LEDS	On	
	Defines the LEDS operation mode. ① OFF - Disables the LEDS operation. ② ON – Enables the LEDS operation.		
②①②⑦④ ZZZ ②	MW (Microwave) Range	Trimmer	
	Defines the microwave channel range. ① MINIMUM ② 25% ③ 50% ④ 65% ⑤ 85% ⑥ MAXIMUM ⑦ TRIMMER (MW is defined by the trimmer setting on the PCB)		
②①②⑦④ ZZZ ③	ACT	No	
	Defines the Anti-Cloak™ Technology (ACT) operation mode. ① NO – Disables the ACT mode ② YES – Enables the ACT mode		
②①②⑦④ ZZZ ④	Automatic Microwave Bypass	No	
	Defines whether the microwave (MW) channel will be bypassed or not while the detector identifies trouble in the MW channel. ① NO - While detecting a problem in the MW channel it is not bypassed. Alarm condition cannot be established until the MW channel is fixed. ② YES - Switches the detector to operate only in PIR mode in case of MW trouble		
②①②⑦④ ZZZ ⑤	Green Line	Yes	
	A feature that follows environmental guidelines by avoiding surplus emission. This feature defines the activation of the microwave channel while the system is disarmed. ① NO - Green Line feature is disabled. MW is constantly activated. ② YES - Green Line feature is activated.		
②①②⑦④ ZZZ ⑥	Self Test	Remote	
	Used to test the detection technologies. In the event of a failed test, a self-test trouble is created. ① REMOTE (Manual) - The remote self-test is performed by the system when a user manually selects the Diagnostics option from the Maintenance menu via the LightSYS Plus User Functions menu ② LOCAL (automatic) - Once an hour, the detector automatically		

Quick Keys	Parameter	Default	Range
	checks that the detector's channels are functioning properly.		

Bus Zone: (Industrial) Lunar /BWare/iWISE DT Grade 3

Quick Keys	Parameter	Default	Range
②①②⑦④ ZZZ ①	LEDS	On	
	Defines the LEDES operation mode. ① OFF - Disables the LEDES operation. ② ON - Enables the LEDES operation.		
②①②⑦④ ZZZ ②	MW (Microwave) Range	Trimmer	
	Defines the microwave (MW) channel range. ① MINIMUM ② 25% ③ 50% ④ 65% ⑤ 85% ⑥ MAXIMUM ⑦ TRIMMER (MW is defined by the trimmer setting on the PCB)		
②①②⑦④ ZZZ ③	ACT	No	
	Defines the Anti-Cloak™ Technology (ACT) operation mode.. ① NO - Disables the ACT mode ② YES - Enables the ACT mode		
②①②⑦④ ZZZ ④	Automatic Microwave Bypass	No	
	Defines whether the microwave channel will be bypassed or not while the detector identifies trouble in the MW channel. ① NO - While detecting a problem in the MW channel it is not bypassed. Alarm condition cannot be established until the MW channel is fixed. ② YES - Switches the detector to operate only in PIR mode in case of MW trouble		
②①②⑦④ ZZZ ⑤	Green Line	Yes	
	A feature that follows environmental guidelines by avoiding surplus emission. This feature defines the activation of the microwave channel while the system is disarmed. ① NO - Green Line feature is disabled. MW is constantly activated. ② YES - Green Line feature is activated.		
②①②⑦④ ZZZ ⑥	Anti-Mask	Enable	
	Defines the operation of anti-masking detection.		

Quick Keys	Parameter	Default	Range
	① DISABLE ② ENABLE and behaves according to the settings defined in quick keys ②①②⑦④ZZZ⑦		
②①②⑦④ ZZZ ⑦	Arm/Disarm	No	
	Defines the operation of the anti-masking detection while the detector is armed or disarmed. ① NO – While armed or disarmed, anti-mask behaves according to the setting defined in quick keys ②①②⑦④ZZZ⑥above. ② YES – While armed, anti-mask is disabled. When detector is disarmed Anti-mask behaves according to the settings defined in quick keys ②①②⑦④ZZZ⑥.		
②①②⑦④ ZZZ ③	Self Test	Remote	
	Used to test the detection technologies. In the event of a failed test, a self-test trouble is created ① REMOTE (Manual) - The remote self-test is performed by the system when a user manually selects the Diagnostics option from the Maintenance menu via the LightSYS Plus User Functions menu ② LOCAL (automatic) - Once an hour, the detector automatically checks that the detector’s channels are functioning properly.		

Bus Zone: iWISE QUAD Grade 2

Quick Keys	Parameter	Default	Range
②①②⑦④ ZZZ ①	LEDS	On	
	Defines the LEDES operation mode. ① OFF - Disables the LEDES operation. ② ON - Enables the LEDES operation		
②①②⑦④ ZZZ ②	PIR Sensitivity	High	
	Defines the PIR sensitivity of the detector. ① LOW ② HIGH		
②①②⑦④ ZZZ ③	Self Test	Remote	
	Used to test the detection technologies. In the event of a failed test, a self-test trouble is created		

Quick Keys	Parameter	Default	Range
	<p>① REMOTE (Manual) - The remote self-test is performed by the system when a user manually selects the Diagnostics option from the Maintenance menu via the LightSYS Plus User Functions menu</p> <p>② LOCAL (automatic) - Once an hour, the detector automatically checks that the detector's channels are functioning properly</p>		

Bus Zone: iWISE/BWare QUAD Grade 3

Quick Keys	Parameter	Default	Range
②①②⑦④ ZZZ ①	LEDS	On	
	<p>Defines the LEDS operation mode.</p> <p>① OFF - Disables the LEDS operation.</p> <p>② ON - Enables the LEDS operation.</p>		
②①②⑦④ ZZZ ②	PIR Sensitivity	High	
	<p>Defines the PIR sensitivity of the detector.</p> <p>① LOW ② HIGH</p>		
②①②⑦④ ZZZ ③	Anti-Mask	Enable	
	<p>Defines the operation of anti-masking detection.</p> <p>① DISABLE</p> <p>② ENABLE and behaves according to the settings defined in quick keys ②①②⑦④ZZZ④</p>		
②①②⑦④ ZZZ ④	Arm/Disarm	No	
	<p>Defines the operation of the anti-masking detection while the detector is armed or disarmed.</p> <p>① NO - While armed or disarmed, anti-mask behaves according to the setting defined in quick keys ②①②⑦④ZZZ③ above.</p> <p>② YES - While armed, anti-mask is disabled. When detector is disarmed Anti-mask behaves according to the settings defined in quick keys ②①②⑦④ZZZ③.</p>		
②①②⑦④ ZZZ ⑤	Self Test	Remote	
	<p>Used to test the detection technologies. In the event of a failed test, a self-test trouble is created</p> <p>① REMOTE (Manual) - The remote self-test is performed by the</p>		

Quick Keys	Parameter	Default	Range
	system when a user manually selects the Diagnostics option from the Maintenance menu via the LightSYS Plus User Functions menu 2 LOCAL (automatic) - Once an hour, the detector automatically checks that the detector's channels are functioning properly.		

Bus Zone: ODT15 (WatchOUT DT)

Quick Keys	Parameter	Default	Range
2 1 2 7 4 ZZZ 1	LEDS	3 LEDS	
	Defines the LEDS operation mode. 1 OFF - Disables the LEDS operation. 2 RED ONLY - Only the Red LED will operate. This option is highly recommended to avoid the possibility that a burglar will "Learn" the detector behavior. 3 3 LEDS - All 3 LEDS will operate.		
2 1 2 7 4 ZZZ 2	PIR Sensitivity	Normal	
	Defines the PIR sensitivity of the detector. 1 LOW 2 MEDIUM 3 NORMAL 4 HIGH		
2 1 2 7 4 ZZZ 3	Microwave Range	Trimmer	
	Defines the microwave channel range. 1 MINIMUM 2 20% 3 40% 4 60% 5 80% 6 MAXIMUM 7 TRIMMER (MW is defined by the trimmer setting on the PCB)		
2 1 2 7 4 ZZZ 4	Anti Mask Sensitivity		
	Defines the sensitivity of the active IR AM: 1 LOW 2 HIGH		
2 1 2 7 4 ZZZ 5	Lens Type	Wide Angle	
	Defines the actual lens of the detector. 1 WIDE ANGLE 2 BARRIER / LONG RANGE		
2 1 2 7 4 ZZZ 6	Anti-Mask	Enable	
	Defines the operation of anti-masking detection. 1 DISABLE 2 Enable		
2 1 2 7 4 ZZZ 7	Arm/Disarm	No	
	Defines the operation of the LEDS and anti-masking detections while the detector is armed. 1 Active IR AM and Proximity AM (anti-masking) is enabled.		

Quick Keys	Parameter	Default	Range
	LEDs behave according to the LEDs parameter definition. 2 YES – Active IR AM and Proximity AM (anti-masking) is disabled LEDs are disabled.		
2 1 2 7 4 ZZZ 3	Prox Anti-mask	Enable	
	Defines the operation of proximity anti-masking detection. 1 DISABLE 2 ENABLE		

Bus Zone: WatchIN DT Grade 3

Quick Keys	Parameter	Default	Range
2 1 2 7 4 ZZZ 1	LEDS	3 LEDS	
	Defines the LEDS operation mode. 1 OFF - Disables the LEDS operation. 2 RED ONLY - Only the Red LED will operate. This option is highly recommended to avoid the possibility that a burglar will “Learn” the detector behavior. 3 3 LEDS - All 3 LEDS will operate.		
2 1 2 7 4 ZZZ 2	Detection Sensitivity	Normal	
	Defines the sensitivity of the detector (MW + PIR). 1 LOW 2 MEDIUM 3 NORMAL 4 ACT (Anti-Cloak™ Technology)		
2 1 2 7 4 ZZZ 3	MW (Microwave) Range	Trimmer	
	Defines the microwave channel range. 1 MINIMUM 2 25% 3 50% 4 65% 5 85% 6 MAXIMUM 7 TRIMMER (MW is defined by the trimmer setting on the PCB)		
2 1 2 7 4 ZZZ 4	Alarm Logic	PIR and Microwave	
	Determine the detector’s logic of defining an alarm. 1 PIR & MW (and Microwave) – An alarm is activated when both PIR and MW channels detect an alarm (AND Logic). 2 PIR / MW (or Microwave) - An alarm is activated when either PIR or MW channels detect an alarm (OR Logic).		
2 1 2 7 4 ZZZ 5	Lens Type	Wide Angle	
	Defines the actual lens of the detector.		

Quick Keys	Parameter	Default	Range
	① WIDE ANGLE ② BARRIER / LONG RANGE		
②①②⑦④ ZZZ ⑥	Anti-Mask	Enable	
	Defines the operation of anti-masking detection. ① DISABLE ② ENABLE		
②①②⑦④ ZZZ ⑦	Arm/Disarm	No	
	Defines the operation of the LEDs and anti-masking detections while the detector is armed. ① Active IR AM and Proximity AM (anti-masking) is enabled. LEDs behave according to the LEDs parameter definition. ② YES – Active IR AM and Proximity AM (anti-masking) is disabled LEDs are disabled.		
②①②⑦④ ZZZ ⑧	Green Line	Yes	
	This feature defines the activation of the microwave channel while the system is disarmed. ① NO - Green Line feature is disabled. MW is constantly activated. ② YES - Green Line feature is enabled. This option conforms to environmentally friendly standards by avoiding surplus emission.		
②①②⑦④ ZZZ ⑨	Sway	No	
	This option allows the recognition and immunity of swaying objects in a known pattern. ① NO - Sway is disabled. ② YES - Sway is enabled.		

Bus Zone: Seismic

Quick Keys	Parameter	Default	Range
②①②⑦④ ZZZ ①	Sensitivity	Normal	
	Defines the Seismic sensitivity of the detector. ① LEVEL 1, ② LEVEL 2, ③ LEVEL 3, ④ LEVEL 4, ⑤ LEVEL 5, ⑥ LEVEL 6, ⑦ LEVEL 7, ⑧ LEVEL 8		
②①②⑦④ ZZZ ②	Interference Time	10 Seconds	10, 20, 40, or 80 sec

Quick Keys	Parameter	Default	Range
	Defines the moving window of time in which the vibration signal is accumulated (integrated). Detection is triggered when the accumulated signal reaches a threshold value. Longer time causes higher detection sensitivity.		
②①②⑦④ ZZZ ③	Explosion Sensitivity	Low	
	Defines the explosion sensitivity of the detector. ① LOW ② HIGH		
②①②⑦④ ZZZ ④	Temperature Sensitivity	Off	
	Defines the sensitivity to temperature change. ① OFF ② ON		
②①②⑦④ ZZZ ⑤	Self Test	Remote	
	Used to test the detection technologies. In the event of a failed test, a self-test trouble is created ① REMOTE (Manual) - The remote self-test is performed by the system when a user manually selects the Diagnostics option from the Maintenance menu via the LightSYS Plus User Functions menu ② LOCAL (automatic) - Once an hour, the detector automatically checks that the detector's channels are functioning properly.		
②①②⑦④ ZZZ ⑥	LEDS	On	
	Defines the LEDS operation mode. ① OFF - Disables the LEDS operation. ② ON - Enables the LEDS operation		

Zones→Parameters→By Category→Advanced→Wireless Zones Configuration

Quick Keys	Parameter	Default	Range
②①②⑦⑤	Wireless Zones Configuration		
	The Wireless Zone Parameters menu contains parameters that enable you to program the special parameters of a 1-way or 2-way wireless zone. The options are determined according to the wireless detector type. For example: <ul style="list-style-type: none"> • 2-Way WatchOUT: A dual technology outdoor detector with signal processing based on two Passive Infrared (PIR) channels 		

Quick Keys	Parameter	Default	Range
	and two Microwave (MW) channels.		
	<ul style="list-style-type: none"> • 2-Way Magnet: Contact detector (x73) – models include shutter and universal • 2-Way IR Beams • 1 & 2-Way Smoke detector • 2-Way PIR • Also Shock, Flood, Gas, CO, and Curtain detectors 		
	Use the instructions below to set parameters for the relevant wireless zone detector. Also see the instructions packaged with each detector.		

Wireless Zones: 1-Way and 2-Way Smoke

Quick Keys	Parameter	Default	Range
②①②⑦⑤ZZZ①	Serial No.		
	The identifying 11-digit number on the detector sticker		
②①②⑦⑤ZZZ②	Control		
②①②⑦⑤ZZZ②①	Supervision	No	Yes/No
	Determines if this zone will be supervised by the system expander according to the time defined under the timer RX Supervision (see <i>RX Supervise</i> , page 81).		
②①②⑦⑤ZZZ②②	LED Enable	Yes	Yes/No
	Defines whether or not the LEDS operation mode is enabled		
②①②⑦⑤ZZZ③ (2-Way Smoke Only)	Operation Mode	Smoke & Heat	S/H/S&H
	Defines the detector operation mode. ① SMOKE ② HEAT ③ SMOKE & HEAT		

Wireless Zones: 2-Way PIR, WatchOUT and Wireless IR Beam

Quick Keys	Parameter	Default	Range
②①②⑦⑤ZZZ①	Serial No.		
	The identifying 11-digit number on the detector sticker		
②①②⑦⑤ZZZ②	Control		
②①②⑦⑤ZZZ②①	Supervision	No	Yes/No

Quick Keys	Parameter	Default	Range
	Determines if this zone will be supervised by the system expander according to the time defined under the timer RX Supervision (see <i>RX Supervise</i> , page 81).		
②①②⑦⑤ZZZ②②	LED Enable	Yes	Yes/No
	Defines whether or not the LEDES operation mode is enabled		
②①②⑦⑤ZZZ②③	Anti Mask (WatchOUT Only)	No	Yes/No
	Defines the operation of anti-masking detection and behaves according to the settings defined in quick keys ②①②⑦④ZZ⑦		
②①②⑦⑤ZZZ③	Detection Mode	2.5 Min	2.5 min/ 2.5 sec
	① Normal 2.5 Min ② Fast 2.5 Sec If automatic detection mode is enabled, designate here the polling periodicity of alarm generating events.		
②①②⑦⑤ZZZ④	Sensitivity		
	<ul style="list-style-type: none"> Defines the visual sensitivity of the detector. <ul style="list-style-type: none"> ① LOW ② HIGH ① LOW ② MEDIUM ③ HIGH ④ MAXIMUM (WatchOUT only) (For IR Beam) Defines the sensitivity of the detector (how long must the beam transmission be interrupted to generate an alarm event) <ul style="list-style-type: none"> ① LOW 900 mSEC ② MEDIUM 675 mSEC ③ HIGH 450 mSEC ④ MAXIMUM 225 mSEC 		

Wireless Zones: 2-Way Magnetic Contact Detector (X73)

Quick Keys	Parameter	Default	Range
②①②⑦⑤ZZZ①	Serial No.	Normal	
	The identifying 11-digit number on the detector sticker		
②①②⑦⑤ZZZ②	Control		
②①②⑦⑤ZZZ② ①	Supervision	No	Yes/No
	Determines if this zone will be supervised by the system expander according to the time defined under the timer RX Supervision (see <i>RX Supervise</i> , page 81).		
②①②⑦⑤ZZZ② ②	LED Enable	Yes	Yes/No

	Defines whether or not the LEDS operation mode is enabled		
②①②⑦⑤ZZZ⑤	(M&F Univ only) Magnet Enable	Yes	Yes/No
	① Yes (Enable) or ② No (disable) the transmitter's magnet.		
②①②⑦⑤ZZZ⑥	Alarm Hold On	On	On/Off
	Use this parameter to define the minimum period between alarm broadcasts. ON: Only one alarm message is transmitted in any 2.5 minute time-period OFF: Alarm detection is immediately transmitted		
②①②⑦⑤ZZZ⑦	Input Termination	N/O	N/O, N/C, DEOL
	Use this parameter to program the connection type used for each of the system's zones ① (F Shutter only) Shutter: Specifies that the Input 2 will count the number of open and close pulses received. If the zone exceeds the predefined number of pulses, the zone will be tripped and act according to its type definition. After a 25-second timeout, the pulse counter is restarted. The pulse length is the currently defined Loop Response time period. ② N/O: Uses normally-open contacts and no terminating End-of-Line Resistor ③ N/C: Uses normally-closed contacts and no terminating End-of-Line Resistor. ④ DEOL: Uses normally-closed (NC) contacts in a zone using two 10 KΩ of End-of-Line Resistors to distinguish between alarms and tamper conditions		
②①②⑦⑤ZZZ⑧	Input Response Time	500	10/500mSEC
	① 10 mSEC ② 500mSEC Set the duration for which a zone violation must exist in order for the zone to trigger an alarm condition.		
②①②⑦⑤ZZZ⑨	(F Univ. only) Anti-Sabotage	Disable	Enable/Disable
	① Enable or ② disable the transmitter's anti-sabotage magnet.		
②①②⑦⑤ZZZ⑩	(F SP only) Shutter Pulse	02	01 – 16

Define here the number of pulses for the input.

Presence

Quick Keys	Parameter	Default	Range
②①②⑦⑥ZZZ	Zone=001 (0:E00:01)	Disable	Enable/Disable
<p>A zone that is set as Presence will send a push notification to the end-user when triggered during disarm state.</p> <p>NOTE: Presence is applicable to all wired and wireless detectors except for Beyond/PIR Camera Detectors.</p> <p>❶ Enable or ❷ Disable sending a push notification to the end-user.</p> <p>Notes</p> <ul style="list-style-type: none"> • The Presence push notifications option must also be selected in the RISCO Cloud for the notifications to be sent to the end-user's smartphone. • The Presence zone can also be muted via the RISCO Cloud. 			

Resistance

Define termination resistance for the wired zones. See *Defining Zone Termination Resistance*, page 47 and also the Resistance parameters below:

Zones → Parameters → Resistance

Quick keys	Parameter	Default	Range
②①③	Resistance		

You can define separately the end-of-line termination resistance of relay zones and zone expanders.

1. Scroll to select the termination resistance value(s) for a wired zone (relay detector, zone expander).

2. Press **OK**.

NOTE: When adding a zone expander (8-zone), define the termination resistance compatibility for the zone expander itself, according to the “highest” level of any relay detector you intend to connect to it. For example, if you have EOL, DEOL and TEOL detectors connected to the zone expander (or if you have only EOL and DEOL detectors, but you want to leave open the possibility of adding a TEOL detector to the zone expander in the future), you’ll need to set the zone expander’s termination resistance values to TEOL – the “highest” level.

NOTE: For retrofit installations, define the resistance compatibility according to the resistors already installed in the relay detectors.

Zone Termination Resistance Value in Ohms

	EOL	DEOL	TEOL		EOL	DEOL		EOL	DEOL
00	Custom			05	3.74K	6.98K	10	3.3K	3.3K
01	2.2K (default)	2.2K, 2.2K (default)		06	2.7K	2.7K	11	5.6K	5.6K
02	4.7K	6.8K	4.7K, 6.8K, 12K, (default)	07	4.7K	4.7K	12	2.2K	1.1K
03	6.8K	2.2K		08	3.3K	4.7K	13	2.2K	4.7K
04	10K	10K		09	1K	1K			

②② Testing

The Testing sub-menu has the following system tests. Also see *Testing the System*, page 227.

- **Self Test**

- Soak Test

Zones → Testing → Self Test

Quick keys	Parameter	Default	Range
② ② ①	Self Test		
<p>This feature provides an automated self-test for a selected group of localized intrusion sensors (for example, glass break detectors, sound discriminators and shock sensors) which respond to an artificial source of noise and/or vibration.</p> <p>Automated self-testing is especially useful when sensors are placed in high security areas where failure cannot be tolerated.</p> <p>Up to 16 zones can be designated for self-testing.</p> <p>A sound or vibration generator should be used that can be placed close enough to the sensors to trigger them when the noise source is activated. A Programmable Output acts as the source of switched power for the noise/vibration generator (see <i>Sensors Test, page 144</i>).</p> <p>This is set to conform to the testing schedule. The schedule defines the time and day for the first test, and sets the times for repeated tests over a 24-hour period.</p> <p>A message is sent to the monitoring station if all the related sensors are triggered during the test (if a report code has been defined). With successful completion of the self-test, an entry is also placed in the event log.</p> <p>If one or more of the sensors fails to trip during the test period, a self-test failure message is generated and sent to the monitoring station. A record of the failure is also entered in the event log.</p>			

Zones → Testing → Soak Test

Quick keys	Parameter	Default	Range
②②②	Soak Test		
<p>The Soak Test feature is designed to allow false alarms for predefined detectors to be bypassed from the system, while any alarms generated are displayed to the user for reporting to the monitoring station. This is especially useful to prevent unnecessary police response and when a particular zone is causing unidentified problems.</p> <p>Up to 20 zones can be placed on Soak Test. Any zone placed in the Soak Test list is bypassed from the system for 14 days and is automatically reinstated after that time if no alarms have been generated by it.</p> <p>If a zone in the Soak Test list has an alarm during the 14-day period, the keypad indicates to the user that the test has failed. After the user looks at the View Trouble option the trouble message will be erased. This will be indicated in the event log, but no alarm will be generated. The alarmed zone's 14-day Soak Test period is then reset and restarted.</p> <ol style="list-style-type: none"> From the installer Programming menu, press ②②②. The following appears: ZONES FOR TEST: 001) ZONE 001 N Scroll to the zone you wish to perform the Soak Test for, and then toggle to Y (to perform the test), or N. Press OK. To add other zone(s) to be tested, repeat the procedure for all additional zone(s). <p>EN 50131-3 Note The Soak Test function is not in compliance with EN50131-3.</p>			

②③ Cross Zones

The Cross Zones menu is used for additional protection from false alarms and contains parameters that enable you to link together two related zones. Both must be violated within a designated time period (between 1 and 9 minutes) before an alarm occurs. This type of linking is used with motion detectors in hostile or false-alarm prone environments. The LightSYS Plus allows 50 unique sets of zone links (pairs of zones), which can be manually specified, as required. Zones crossed with themselves are valid pairs. They need to register a violation twice to trigger the alarm. This process is known as Double Knock. You may want to establish a number of zone links, but leave them deactivated at this time (see below).

Zones → Cross Zones

Quick keys	Parameter	Default	Range
② ③	Cross Zones	None	
<ol style="list-style-type: none"> From the installer Programming menu, press ② ③. The following appears: ZONES CROSSING: 01) 001 S 001 You are at the first set of zone links(01) – or scroll to go to the next set of zone links (50 sets maximum) ; the following displays: CROSSING SET 01: 1ST = 001 2ND=001 Select the zone sets manually, as required, by making changes to the number of the first zone in the set, followed by the number of the second zone. If necessary, toggle between all the possibilities for each digit (you can also scroll to them). <p>Note Zones crossed with themselves are valid pairs. They need to register a violation twice to trigger the alarm. This process is known as Double Knock.</p> <ol style="list-style-type: none"> Press OK to display the correlation type screen where you select how the system will process violations of the paired zones: <ul style="list-style-type: none"> ① NONE– Not correlated: Temporarily disables any associated zone pairings ② ORDERED–Correlated: Effects an alarm so the first listed zone is tripped before the second ③ NOT ORDERED–Correlated: Affects an alarm in which either zone in the pair may be tripped first. In this case, the specified zone order (1st, 2nd) has no bearing on the alarm activation. Press OK to display the alarm violation differential screen: T.SLOT: XXX,YYY SIZE=1 MINUTES Enter the time slot, meaning the maximum amount of time allowed between the triggering events for them to be considered a valid violation (XXX, YYY indicate the crossed zones). Default: 1 min Range: 1 to 9 minutes Repeat the entire process, as required, for any additional zone links (up to 50). 			

②④ Alarm Confirm

The Alarm Confirm sub-menu enables you to define the following that can be used for alarm verification:

- Confirm Partition
- Confirm Zones

Zones → Alarm Confirm → Confirm Partition

Quick keys	Parameter	Default	Range
②④①	Confirm partition		
<p>Defines which partitions are to be defined for alarm sequential confirmation (relevant for intrusion alarms, not HU Confirmation alarms).</p> <p>Each confirmed partition has a separate timer (time period), which is equivalent to the confirmation time defined in “Confirmation Time Window” (see <i>Confirm Time</i> , page 182).</p> <p>A confirmed intrusion alarm will be reported to the monitoring station if two separate alarm conditions are detected in the same confirmed partition, during the period of the confirmation time window.</p> <ul style="list-style-type: none"> • Cycle through the partitions and toggle to Y/N for each. 			

Zones → Alarm Confirm → Confirm Zones

Quick keys	Parameter	Default	Range
②④②	Confirm zones		
<p>Define which zones are to be defined for alarm sequential confirmation (relevant for intrusion alarms, not HU Confirmation alarms).</p> <p>When the first zone goes into alarm the system transmits the first zone alarm. When the second zone goes into alarm, during the confirmation time, the panel transmits the zone alarm and the police code.</p> <p>Notes</p> <ul style="list-style-type: none"> • A confirmed zone will be part of the sequential confirmation only if the partition in which the alarm occurs is defined as confirmed partition as well. • Any code can reset a confirmed alarm. • If the first zone is violated and not restored until the end of the confirmation time (no second zone alarm), then this zone will be excluded from the confirmation process until the next arming. • Cycle through the zones and toggle to Y/N for each. 			

③ Outputs

The Utility Output menu provides access to the following submenus and their related programming parameters that enable you to choose among the following event types that will trigger a selected Utility Output, as well as the manner in which the output will be applied:

- **Nothing**
- **System**
- **Partition**
- **Zone**
- **Code**

③① Nothing

This parameter is for disabling a previously enabled utility output.

Note

When selecting output utility output number (1–10), if the UO number appears with a 0 first (for example 0xx, whereas xx is the UO number) that indicates the UO is connected directly to the terminal block and not assigned to an output expander.

1. From the installer Programming menu go to **3)Outputs** and then press **OK** (✓).
2. Scroll to a UO number to disable (1–10), and press **OK**.
3. Scroll to **0)Nothing** and then press **OK**.
4. Scroll to additional programmed outputs to disable, then press **OK** after each.

Outputs → Nothing

Quick keys	Parameter	Default	Range
③xx ① ①	Nothing		
Disables a previously enabled programmable output			

③① System

Define parameters that follow system events.

Note

When selecting output utility output number (1–10), if the UO number appears with a 0 first (for example 0xx, whereas xx is the UO number) that indicates the UO is connected directly to the terminal block and not assigned to an output expander.

1. From the installer Programming menu go to **3)Outputs** and then press **OK** (✓).
2. Scroll to a UO number to configure (1–10), and press **OK**.
3. Scroll to **1)System** and then press **OK**.
4. Scroll to a parameter to configure in the table below, and then press **OK**.
5. Scroll to the pattern of operation option (see *Pattern of Operation for Utility Outputs, page 153*) and then press **OK**.
6. Set other parameters as relevant (such as pulse duration and UO label), and then press **OK** after each.

Outputs → System

Quick keys	Parameter
③xx ① 0 ①	Bell Follow Activates when a bell is triggered. If a bell delay was defined, the utility output will be activated after the delay period.
③xx ① 0 ②	No Telephone Line Activates when a bell is triggered. If a bell delay was defined, the utility output will be activated after the delay period.
③xx ① 0 ③	Communication Failure Activates when communication with the monitoring station cannot be established. Deactivates after a successful call is established with the MS.
③ xx ① 0 ④	Trouble Follow Activates when a system trouble condition is detected. Deactivates after the trouble has been corrected
③ xx ① 0 ⑤	Low Battery Follow Activates when the LightSYS Plus panel's rechargeable standby battery has insufficient reserve capacity and the voltage decreases to 11 V or following an accessory low battery indication.

Quick keys	Parameter
③ XX ① 06	AC Loss Follow
	Activates when the source of the main panel's AC power is interrupted. This activation will follow the delay time defined in the system control times and the AC Off Delay Time parameter (see <i>AC Off Delay page 82</i>).
③ XX ① 07	Sensors Test
	Relates to the LightSYS Plus Zone Self-Test (Quick Keys ②②①) This option is selected if the designated utility output is part of the circuit providing switched power for the source of noise (or vibration) used in the sensors test procedure.
③ XX ① 08	Battery Test
	A pulsed utility output will follow the battery test only once a day at 9:00 AM. The pulse interval is ten seconds. This parameter is usually used to perform an overload test on the system by using an external device.
③ XX ① 09	Bell Burglary
	Activates the utility output after any bell burglary alarm in any partition in the system.
③ XX ① 10	Scheduler
	The utility output will follow the predefined time programming that is defined in the scheduler of the weekly programs for utility output activation. For additional details, refer to the LightSYS Plus User Manual.
③ XX ① 11	Switched Aux
	Activates the utility output when a fire zone is activated (for fire detection) according to the time defined in double verification of fire alarms (see <i>Double Verification of Fire Alarms, page 88</i>). This utility output will not have the option to choose pulse or latch in the Utility Output: Code. The pulse time is defined in <i>Switch Aux Break, page 81</i> .
Quick keys	Parameter
③ XX ① 12	GSM Error
	Relates to the installed GSM module. Activates the utility output in the following cases: <ul style="list-style-type: none"> • There is no SIM card in the GSM module or SIM is faulty • GSM RSSI signal level is low

Quick keys	Parameter
	<ul style="list-style-type: none"> GSM network fault
③ XX ① ① ⑤	Bell Test
	Activates the output when the “Bell Test” option is selected and deactivates when the “Bell Test” option is finished.
③ XX ① ① ④	Installation
	Activates the output following the system installation status. It activates when the system is in installer programming mode and deactivates when exiting installer’s mode.
③ XX ① ① ⑤	Walk Test
	Activates the output when the “Walk Test” option is selected and deactivates when the “Walk Test” option is finished.
③ XX ① ① ⑥	Burglary
	Activates the output (Pulsed only) following any intruder activation in the system (Regardless the bell time out timer). The maximum number of times an output can be activated from the same zone is defined according to the Swinger Limit Timer (Quick key ①① ① ⑨)
③ XX ① ① ⑦	Panic
	Activates the output (Pulsed only) following any panic activation in the system. The maximum number of times an output can be activated from the same zone is defined according to the Swinger Limit Timer (Quick key ①① ① ⑨).
③ XX ① ① ⑧	Fire
	Activates the output (Pulsed only) following any fire activation in the system. The maximum number of times an output can be activated from the same zone is defined according to the Swinger Limit Timer (Quick key ①① ① ⑨).
③ XX ① ① ⑨	Special
	Activates the output (Pulsed only) following any special emergency activation in the system. The maximum number of times an output can be activated from the same zone is defined according to the Swinger Limit Timer (Quick key ①① ① ⑨).

Quick keys	Parameter
③ XX ① 20	24 Hour
	Activates the output (Pulsed only) following any 24 Hour zone activation in the system. The maximum number of times an output can be activated from the same zone is defined according to the Swinger Limit Timer (Quick key ①① 09).

③② Partition

Define parameters that follow partition events.

Note

When selecting output utility output number (1–10), if the UO number appears with a 0 first (for example 0xx, whereas xx is the UO number) that indicates the UO is connected directly to the terminal block and not assigned to an output expander.

1. From the installer Programming menu go to **3)Outputs** and then press **OK** (✓).
2. Scroll to a UO (utility output) to configure (1–10), and press **OK**.
3. Scroll to **2)Partition** and then press **OK**.
4. Scroll to a parameter to configure in the table below, and then press **OK**.
5. Select the partition/s by entering the numbers (you can enter a number again to clear it), and then press **OK**.
6. Scroll to the pattern of operation option (see *Pattern of Operation for Utility Outputs*, page 153), and then press **OK**.
7. Set other parameters as relevant (such as pulse duration and UO label), and then press **OK** after each.

Outputs → Partition

Quick Keys	Parameter
③ XX ② 01	Ready Follow
	Activates the output when all selected partition(s) are in a "ready" state.
③ XX ② 02	Alarm Follow
	Activates the output when an alarm occurs in the selected partition(s).
③ XX ② 03	Arm Follow
	Activates the utility output when the selected partition(s) is armed in either the full (Away) or partial (Stay) arming mode. The utility output will be activated immediately, regardless of the exit delay time period.

③ XX ② 04	Burglary Follow
	Activates the output when an intruder (intrusion) alarm occurs in the selected partition(s).
③ XX ② 05	Fire Follow
	Activates the utility output when a fire alarm is triggered in the selected partition(s) from the keypads or a zone defined as Fire.
③ XX ② 06	Panic Follow
	Activates the utility output when a panic alarm is triggered in the selected partition(s) from the keypads, remote controls or a zone defined as Panic.
③ XX ② 07	Special Follow (Emergency)
	Activates the utility output when a special alarm is triggered in the selected partition(s) from the keypads or a zone defined as Special.
③ XX ② 08	Buzzer Follow
	Activates the output when a keypad in the selected partition(s) sounds its buzzer during auto setting, Exit/Entry delays, and alarm conditions.
③ XX ② 09	Chime Follow
	Activates the output when a keypad in the selected partition(s) sounds its chime.
③ XX ② 10	Exit/Entry Follow
	Activates the output when the selected partition(s) initiates an Exit/Entry delay period.
③ XX ② 11	Fire Trouble Follow
	Activates the output when a Fire Trouble is detected in the selected partition(s).
③ XX ② 12	Day Trouble (Zone)
	Activates when a day zone trouble is detected in the selected partition(s).
③ XX ② 13	Trouble Follow (General)
	Activates the output when a fault condition is detected in the selected partition.

③ XX ② ①④	Stay Follow
	Activates the utility output when the selected partition(s) is armed in the partial (Stay) arming mode.
③ XX ② ①⑤	Tamper Follow
	A latched output activated when a tamper occurs in the selected partition(s) and follows any type of tamper. The output deactivates at tamper reset.
③ XX ② ①⑥	Disarm Follow
	Activates the utility output when the selected partition(s) is disarmed.
③ XX ② ①⑦	Bell Follow
	This output enables the connection of different external sounders to different partitions. Activates the output when one of the defined partitions is in alarm mode and the bell is triggered. It will be activated for the programmed bell time or until the alarm is unset.
	<p>Note</p> <p>The external sounder will not generate any squawk sounds</p>
③ XX ② ①⑧	Bell Stay Off
	<p>This parameter causes the output to function as follows:</p> <ul style="list-style-type: none"> • In full (Away) arming mode, the output will follow the bell activation in the defined partitions. • In partial (Stay) arming mode, the output will not be activated. <p>Note</p> <p>If an alarm occurs in a zone that shares more than one partition and one of the partitions is in full (Away) arming mode (while the other is in partial (Stay) arming mode, the output will be activated, as described above.</p> <ul style="list-style-type: none"> • In partial (Stay) arming mode, a 24-hour zone will not activate this output.
③ XX ② ①⑨	Zone Bypass
	Activates the output when the relevant partitions are in full (Away) arming mode or partial (Stay) arming mode, and any zone in the relevant partitions is bypassed.
③ XX ② ②①	Automatic Arm Alarm
	Activates the utility output when there is a not ready zone at the end of the pre warning time during an auto-arm process. The output restore shall be on Bell- Timeout or at user Disarm.
③ XX ② ②①	Zone Loss Alarm

	Activates the utility output when there is a lost wireless zone in the system. The output restore shall be on Bell-Timeout or at user Disarm.
③ XX ② ②②	<p>Bell Trigger</p> <p>Mainly used for the connection of different external sounders to different partitions in the UK. Activates the output when one of the defined partitions is in alarm mode and the bell is triggered. It will be activated for the programmed bell time out or until alarm is disarmed.</p> <p>This output generates squawk sounds and has a special sound for fire alarms.</p> <p>Note In fire alarm the output will not follow the bell delay time (see <i>Bell Delay, page 81</i>) but will trigger immediately. It will be triggered in pulsed sequence: five seconds on and two seconds off.</p>
③ XX ② ②③	<p>Strobe Trigger</p> <p>A latched output that is used to trigger a strobe. The output is activated when one of the defined partitions is in alarm mode or during squawks. The output will be activated until the alarm is disarmed. The output is also activated in test mode.</p> <p>Note A tamper alarm will not activate the output if all partitions are disarmed.</p>
③ XX ② ②④	<p>Fail To Arm</p> <p>Activates when one of the defined partitions fails to arm and deactivates at user reset.</p>
③ XX ② ②⑤	<p>Confirm Alarm</p> <p>The output activates when a confirmed alarm occurs in a partition and deactivates at the restore of the alarm confirmation. RISCO recommends using this output for the Red-Care STU Confirmed Alarm channel.</p>
③ XX ② ②⑥	<p>Duress Follow</p> <p>Activates the Utility Output when a duress alarm is initiated at the keypad related to the selected partition(s).</p>
③ XX ② ②⑦	<p>HU Confirmation Al. (Hold Up Confirmation Alarm)</p> <p>Activates the output when "Hold-Up Alarm Confirmation" occurs in the selected partition(s). See <i>page 97</i>.</p>
③ XX ② ②⑧	<p>STU Alarm</p> <p>A DIGICOM output to connect the Intruder trigger for the connection to a Red-Care STU or similar device.</p>

③ XX ② 29	STU Panic
	A DIGICOM output to connect the Personal Attack trigger for the connection to a Red-Care STU or similar device.
③ XX ② 30	STU Fire
	A DIGICOM output to connect the Fire trigger for the connection to a Red-Care STU or similar device.
③ XX ② 31	STU Confirm Alarm
	A DIGICOM output to connect the “Confirmed alarm” trigger for the connection to a Red-Care STU or similar device.
③ XX ② 32	Zone Exclude
	Activates the output when any zone is excluded from the confirmation procedure.

③③ Zone

Define parameters that follow zone events. Each utility output can be activated by a group of up to five zones.

Note

When selecting output utility output number (1–10), if the UO number appears with a 0 first (for example 0xx, whereas xx is the UO number) that indicates the UO is connected directly to the terminal block and not assigned to an output expander.

1. From the installer Programming menu go to **3)Outputs** and then press **OK** (✓).
2. Scroll to a UO (utility output) to configure (1–10), and press **OK**.
3. Scroll to **3)Zone** and then press **OK**.
4. Scroll to a parameter to configure in the table below, and then press **OK**.
5. For each utility output, you can define a group of up to five zones. Select the 1st through 5th zone numbers to be in the group, pressing **OK** after each (press **OK** even if you don't specify a zone number for all of the five). If you choose a zone that's not in the system, the keypad will beep - scroll back and enter a valid zone.
6. Scroll to the pattern of operation option (see *Pattern of Operation for Utility Outputs*, page 153), and then press **OK**.
7. Set other parameters as relevant (such as pulse duration and UO label), and then press **OK** after each.

Outputs → Zone

Quick keys	Parameter
③ XX ③ ①	Zone Follow Activates the utility output when the selected zone is tripped. The tripped zone need not be armed to trigger the utility output.
③ XX ③ ②	Alarm Follow Activates the utility output when the selected zone causes an alarm.
③ XX ③ ③	Arm Follow Activates the utility output when the selected zone is armed by the system.
③ XX ③ ④	Disarm Follow Activates the utility output when the selected zones are disarmed.

③④ Code

Outputs → Code

Define parameters for enabling codes (for system users) to activate / deactivate utility outputs.

Notes

- The utility output is activated by entering a user code only if the **Quick UO** parameter under System Control is defined as Disabled. When the Quick UO is defined as Enabled, no user code is required.
- When selecting output utility output number (1–10), if the UO number appears with a 0 first (for example 0xx, whereas xx is the UO number) that indicates the UO is connected directly to the terminal block and not assigned to an output expander.

1. From the installer Programming menu go to **3)Outputs** and then press **OK** (✓).
2. Scroll to a UO (utility output) to configure (1–10), and press **OK**.
3. Scroll to **4)Code** and then press **OK**.
4. By default, the Grand Master appears first (you can scroll to another user instead):
5. Toggle to either **Y** (yes) or **N** (no) for the Grand Master or another user, and then press **OK**.
6. Scroll to the pattern of operation option (see *Pattern of Operation for Utility Outputs*, page 153), and then press **OK**.
7. Set other parameters as relevant (such as pulse duration and UO label), and then press **OK** after each.
8. Repeat from step 3 for all additional users (500 total).

Pattern of Operation for Utility Outputs

The Pattern of Operation enables you to set activation/deactivation options for utility outputs. When the UO is following more than one partition, zone, or user you can choose the logic of the UO activation or deactivation, as follows:

Latch N/O & Latch N/C

For Latch N/O and Latch N/C, you can choose the **activation and deactivation** logic of the utility output to follow either after all the partitions/zones/user codes or after any of the partitions/zones/user codes.

Pulse N/O & Pulse N/C

If the pattern of operation is defined as Pulse N/O or Pulse N/C, you can choose **only the activation** logic of the utility output to follow either after all the partitions/zones/user codes or after any of the partitions/zones/user codes. The deactivation operation follows the defined time period.

Pattern of Operation	Default	Range
Pulse N/C	05 seconds	01—90 seconds

The utility output is always activated (N/C) before it is triggered (pulled down to negative). When triggered, it deactivates for the pulse duration specified below and then reactivates automatically.

1. Choose the desired pulse duration, between **01—90 seconds**.
2. Press **OK (✓)** and set the activation by toggling to **ALL** or **ANY**.
3. Press **OK** and define a label (max 10 characters) for the UO.

Latch N/C		
------------------	--	--

The utility output is always activated (N/C) before it is triggered (pulled down to negative). When triggered, it deactivates and remains deactivated (latched) until the operation is restored.

1. Toggle to either **ALL** or **ANY** to set the activation, and then press **OK (✓)**.
2. Toggle to either **ALL** or **ANY** to set the deactivation, and then press **OK**.
3. Define the output label (max 10 characters), and then press **OK**.

Pulse N/O	05 seconds	01—90 seconds
------------------	------------	---------------

The utility output is always deactivated (N/O) before it is triggered (pulled up). When triggered, it activates (is pulled down) for the pulse duration specified below, then deactivates automatically.

1. Choose the desired pulse duration, between **01—90 seconds**.
2. Press **OK (✓)** and set the activation by toggling to **ALL** or **ANY**.
3. Select a label for the UO (max 10 characters), and then press **OK**.

Latch N/O		
<p>The utility output is always deactivated (N/O) before it is triggered (pulled up). When triggered, it activates (is pulled down) and remains activated (latched) until the operation is restored.</p> <ol style="list-style-type: none"> 1. Toggle to select ALL or ANY to set the activation, and then press OK (✓). 2. Toggle to select ALL or ANY to set the deactivation, and then press OK. 3. Define the output label (max 10 characters), and then press OK. 		

③⑤ STU Testing

For the UK only.

④ Codes

Define code parameters for the following:

- **User:** Assign to each system user
- **Grand Master:** For the system-responsible, or chief user
- **Installer code:** for the installer/technician
- **Sub-installer:** for an installer/technician sent to carry out restricted tasks (restricted access) that are defined at the time of system installation by the primary installer/technician
- **Code length:** Configure code length for Grand Master, installer and sub-installer (also configure per Grade requirement)

NOTE: The installer designate codes to be either 4 or 6 digits in length. If defined as 6 digits, the length apply for everybody - all users/installers, however if defined as 4 digits, Grand Master, Installer, and Sub-Installer must have 4-digit codes, while system users can have codes of various lengths, from 1–4 digits.

The installer typically performs the following for the user codes:

- Determines the authority level for each system user (default level is **User**)
- Designates which partitions can be operated (armed/disarmed) per user code
- Changes the Grand Master, installer, and sub-installer codes
- Modifies code length as necessary (see note above under Code Length)

④① User

Define user codes by assigning each user a specific authority level and specific partitions. Up to 499 codes for system users (including Grand Master) can be defined in the system.

Note

For defining user codes, see *Defining User Codes, page 75*.

Codes → User

Quick keys	Parameter	Default	Range
④① YYY①	Partition		
	Specify the partition(s) for which the designated user can have access by using. Press a number to assign, or press the same number again to clear it.		
④① YYY②	Authority Level		
	<p>Assign the authority level of each user (for each user code). There are 8 authority levels (not including the Grand Master level). Toggle between the different levels:</p> <ul style="list-style-type: none"> • Master: There are no restrictions in the number of master codes (as long as they do not exceed the number of codes remaining in the system). <ul style="list-style-type: none"> ○ Restricted to assigning and changing user codes belonging to those with authority levels of master and below (user, arm only, maid, unbyypass, guard, UO control) ○ Restricted access to designated partitions • User: There are no restrictions in the number of user codes (as long as they do not exceed the number of codes remaining in the system). The user has access to the following: <ul style="list-style-type: none"> ○ Arming and disarming ○ Bypassing zones ○ Accessing designated partitions ○ Viewing system status, trouble, and alarm memory ○ Resetting the switched auxiliary output ○ Activating designated utility outputs ○ Changing his/her own user code • Arm Only: There are no restrictions in the number of Arm Only codes (as long as they don't exceed the number of codes remaining in the system). Arm Only codes are useful for workers who arrive when the premises are already open, but because they are last to leave, they're given the responsibility to close the premises and arm the system. The users with Arm Only codes have access for arming one or more partitions, and cannot change their own code. 		

Quick keys	Parameter	Default	Range
	<ul style="list-style-type: none"> • Maid: The maid code is a temporary code, which is automatically and immediately deleted from the system as soon as it is used to arm. This code is typically used for maids, home attendants, and repairmen who must enter the premises before the owner(s) arrive. These codes are used as follows: <ul style="list-style-type: none"> ○ For one-time arming in one or more partitions. ○ If first used to disarm the system, the Maid code may be used once for subsequent arming. ○ After deleted, the code will need to be redefined by the Grand Master for the next usage. ○ Cannot change own code • Unbypass: This user has access to all the user's privileges apart from bypassing zones. • Guard: This user can arm/disarm the system. After entering the Guard code, the system will be disarmed for the predefined time period. The user can also decide to arm the system before the automatic predefined time period (See: <i>Guard Delay page 82</i>). • Duress: When forced to disarm the system (under duress), the system sends a duress alarm to the monitoring station, but the panel is silent. The duress code can be used by all system users, regardless of authority level. • UO Control: <ul style="list-style-type: none"> ○ Used to only operate Utility Output(s) ○ Cannot change own code 		

④② Grand Master

Codes → Grand Master

Default = **1234**. The Grand Master code is used by the system-responsible (for example, the owner), and has the highest authority level. The Grand Master can change the Grand Master code (in the User menu).

Notes

- The Grand Master is index number 00.
- The Grand Master, the installer and the sub-installer can enter and change their codes, but the new codes entered don't display at the keypad – instead **** displays .

④③ Installer

Codes → Installer

Default = 1111. The Installer code provides access to the installer Programming menu as well as all other installer menus, allowing modification of system parameters. The installer can change the installer code.

④④ Sub Installer

Codes → Sub-installer

Default = 2222. The sub-installer code allows limited access to selected installer programming parameters. It is recommended to change the code to one that is unique. The sub-installer is prohibited from accessing the following parameters:

- **Default enable** (to change the panel back to default factory settings)
- **Code length**
- **Installer code**
- **Communication menu**
- **Customer ID**
- **Standards**

④⑤ Code Length

Codes → Code Length

The installer, sub-installer, and Grand Master can define the number of digits. The installer designates the codes to be either 4 or 6 digits in length. If defined as 6 digits, the length apply for everybody - all users/installers, however if defined as 4 digits, Grand Master, Installer, and Sub-Installer must have 4-digit codes, while the system users can codes of various lengths, from 1–4 digits.

Notes

- When you change the code length parameter, all user codes are deleted and must be re-programmed or downloaded.
- For a 6-digit code length system, 4-digit default codes like 1-2-3-4 (Grand Master), 1-1-1-1 (Installer), and 2-2-2-2 (Sub-Installer) become 1-2-3-4-0-0, 1-1-1-1-0-0, and 2-2-2-2-0-0, respectively.
- If you change the code length back to 4 digits, the system codes are restored to the default 4-digit codes.

EN 50131 Notes

- ❖ If EN 50131 Grade 2 is selected, all users code length must be exactly 4 digits: xxxx
- ❖ If EN 50131 Grade 3 is selected, all users code length must be exactly 6 digits: xxxxxx
- ❖ In any configuration, UO Controller code length are up to 6 digits.
- ❖ For each digit 0-9 can be used
- ❖ Invalid codes cannot be created since after 4/6 digits are input, the "Enter" is automatic.
- ❖ Codes are rejected when trying to create a code in the wrong format.

⑤ Communication

Define the following parameters for establishing system communication:

- Method
- Monitoring Station
- Configuration Software
- Follow Me
- Cloud

⑤① Method

Define communication channel parameters for the following methods:

- PSTN
- GSM
- IP
- LRT

Communication → Method → PSTN

Quick keys	Parameter	Default	Range
⑤①①	PSTN		
	The PSTN screens contain parameters for the communication of the LightSYS Plus over the PSTN network.		
⑤①①①	Timers		
	Timers related to communication through the PSTN channel		
⑤①①① ❶	PSTN Lost	4 minutes	0—20 minutes
	The time after which the system will regard the PSTN line as lost. This time also specifies the delay before reporting the event into the event log or operating a utility output that follows this event. 00 indicates no supervision of the phone line.		
⑤①①① ❷	Wait for Dial Tone	3	0—255 seconds
	The number of seconds the system waits to detect a dial tone.		

Quick keys	Parameter	Default	Range
⑤①①②	Control		
⑤①①② ❶	Alarm Phone Line Cut	No	Yes/No
	<p>YES: Activates the external sirens if the land line, connected to the LightSYS Plus panel is cut or the telephone service is interrupted for the time defined in the PSTN Lost time parameter.</p> <p>NO: No activation occurs.</p>		
⑤①①② ❷	Answering Machine Override	Yes	Yes/No
	<p>YES: The Answering Machine Override is enabled, as follows:</p> <ol style="list-style-type: none"> 1. The configuration software at the alarm company calls the account. 2. The software hangs up after one ring by the CS operator. 3. Within one minute, the software calls again. 4. The Light Plus is programmed to pick up this second call on the first ring, thus bypassing any interaction with the answering machine. <p>Note This feature is used to prevent interference from an answering machine with remote configuration software operations.</p> <p>NO: The answering machine override is disabled, and communication takes place in the standard manner.</p>		
⑤①①③	Parameters		
⑤①①③ ①	Dial Method	DTMF	
	<p>When selecting the dialing method, your choice must be compatible with the type of phone service available at the protected premises. Scroll between the options:</p> <ul style="list-style-type: none"> ❶ DTMF (touch-tone) ❷ PULSE, 20BPS ❸ PULSE, 10BPS 		
⑤①①③ ❷	Rings To Answer	12	01 – 15
	The number of rings before the system answers an incoming call		
⑤①①③ ❸	Area Code		
	The system area telephone code. This code will be deleted from a telephone number while the system tries to dial the number through the PSTN network.		

Quick keys	Parameter	Default	Range
⑤①①③④	PBX Prefix		
	A number dialed to access an outgoing line when the system is connected to a Private Branch Exchange (PBX) and not directly to a PSTN line. This number will be added automatically by the system while trying to call from a PSTN line.		
⑤①①③⑤	Call Wait		
	Enter a string to prevent call waiting from interrupting the system during a report to the monitoring station, as defined by your local telephone provider, for example: *70. This string will only appear during the first attempt to send a report to a MS number (PSTN or GSM).		
	<p>Note</p> <p>Do not use the Call Wait feature inappropriately. Using this feature on a line with no call waiting will prevent successfully reporting to the monitoring station.</p>		

Communication → Method → GSM

Quick Keys	Parameter	Default	Range
⑤①②	GSM		
	The GSM screen contains parameters for the communication of the system over the GSM/GPRS/3G/4G network.		
⑤①②①	Timers		
	Allows to program timers related to operation with the GSM module		
⑤①②①①	GSM Lost	1 minute	001—255 minutes
	The period length during which the reception is below the minimum threshold (defined by the GSM Network Sensitivity parameter) that triggers the panel to send a report of GSM Lost. (⑤①②⑤④)		
⑤①②①②	GSM Network Loss	10 minutes	001—255 minutes
	The period length after which the panel will send a report of GSM network loss to the monitoring station.		

⑤①②①③	SIM Expire	0 months	00—36 months
<p>A pre-paid SIM card has a defined life length defined by the provider. After each charging of the SIM, the user will have to manually reset the expiration time of the SIM card. Thirty days before the expiring date, a notification will be displayed on the keypad’s LCD.</p> <p>Set the SIM expiring date (in months) using the numeric keys, according to the time given by the provider.</p>			

⑤①②①④	MS Polling	00000	0—65535 times
<p>The time period that the system will establish automatic communication (polling) with the monitoring station over GPRS/3G/4G, in order to check the connection.</p> <p>3 polling times can be defined: Primary, Secondary and Backup. For each time period define the number of units between 1- 65535. Each unit represents a time frame of 10 seconds.</p>			

- Notes**
- When using the polling feature through GPRS/3G/4G the MS channel parameter must be defined as GPRS/3G/4G only.
 - The report code for MS polling is 999 (Contact ID) or ZZ (SIA)
 - When the GPRS/3G/4G Primary polling time is defined as 0, no polling message is sent to the MS

The use of these time periods depends on the reporting order to the MS defined by the Report Split MS Urgent parameter. See: ⑤①② (Communication → MS → Report Split).

The following table describes how the three MSs use the primary, secondary and backup time intervals in the various MS report split options.

MS report Urgent events	MS 1 Polling State	MS 2 Polling State	MS 3 Polling State
Do not call	N/A	N/A	N/A
Call 1 st	Primary	N/A	N/A
Call 2 nd	N/A	Primary	N/A
Call 3 rd	N/A	N/A	Primary
Call All	Primary	Primary	Primary

1 st Backup 2 nd	Primary	If (MS 1 is OK) Secondary else (MS#1 Fails) Backup	N/A
1 st Backup 2 nd 3 rd	Primary	If (MS#1 is OK) Secondary else (MS#1 Fails) Backup	If (MS#2 is OK) Secondary else (MS#2 Fails) Backup
1 st Backup 3 rd Call 2 nd	Primary	Primary	If (MS#1 is OK) Secondary else (MS#1 Fails) Backup
2 nd Backup 3 rd Call 1 st	Primary	Primary	If (MS#2 is OK) Secondary else (MS#2 Fails) Backup

MS Polling example:

When selecting MS 1 (GPRS/3G/4G), MS 2 (GPRS/3G/4G) and split report option 1st Backup 2nd (using the default primary, secondary and backup time intervals), the report process will be as follows:

In a normal state:

Polling through the GPRS/3G/4G network using the GSM module will occur every 90 seconds according to the primary time interval to MS 1 and every 3600 seconds (1 hour) according to the secondary time interval to MS 2.

When communication to MS 1 fails, polling occurs every 90 seconds according to the backup interval to MS 2. When communication returns to MS 1, polling reverts back to the secondary time interval and occurs every 3600 seconds (1 hour) to MS#2.

⑤①②②	GPRS		
	Allows programming parameters that relate for the communication over the GPRS/3G/4G network.		
⑤①②②①	APN Code		
	To establish a connection to the GPRS/3G/4G network an APN (Access Point Name) code is required. The APN code differs from country to country and from one provider to another (the APN code is provided by your cellular provider). The LightSYS Plus supports an APN code field of up to 30 alphanumeric characters and symbols (!, &, ? etc.).		
⑤①②②②	APN User Name		
	Enter user name for the GPRS/3G/4G network (if required). The user name is provided by your provider. The LightSYS Plus supports a user name field of up to 20 alphanumeric characters and symbols (!, &, ? etc.).		
⑤①②②③	APN Password		
	The password to the GPRS/3G/4G network as provided by your provider (if required). The LightSYS Plus supports a user name field of up to 20 alphanumeric characters and symbols.		
⑤①②③	Email		
	The following programming parameters are used to enable sending Follow Me event messages by e-mail through GPRS/3G/4G. Note To enable e-mail messaging, the GPRS/3G/4G parameters have to be defined.		
⑤①②③①	Mail Host	000.000.000.000	
	The IP address or the host name of the SMTP mail server.		
⑤①②③②	SMTP Port	00000	00000—65535
	The port address of the SMTP mail server.		
⑤①②③③	Email Address		
	The Email address that identifies the system to the mail recipient.		

⑤①②③④	SMTP User Name		
	A name identifying the user to the SMTP mail server The user name field can include up to 10 alphanumeric characters and symbols (!, &, ? etc.).		
⑤①②③⑤	SMTP Password		
	The password authenticating the user to the SMTP mail server The password can include up to ten alphanumeric characters and symbols (!, &, ? etc.).		
⑤①②④	Controls		
	Allows controlling timers related to operation with the GSM module.		
⑤①②④①	Caller ID	No	Yes/No
	The Caller ID function enables to restrict SMS remote control operations to the predefined Follow Me phone numbers. If the incoming number is recognized as one of the Follow Me numbers, the operation will be executed.		
⑤①②④②	LED Enable	No	Yes/No
	Defines whether or not the LEDS operation mode is enabled		
⑤①②⑤	Parameters		
	Allows to program timers related to the operation with the GSM module.		
⑤①②⑤①	PIN Code		
	The PIN (Personal Identity Number) code is a 4 to 8 digit number giving you access to the GSM network provider. Note You can cancel the PIN code request function by inserting the SIM card into a regular mobile phone and according to the phone settings, disable this function.		
⑤①②⑤②	SIM Number		
	The SIM phone number. The system uses this parameter to receive the time from the GSM network in order to update the system time.		
⑤①②⑤③	SMS Center Phone		
	A telephone number of the message delivery center. This number can be obtained from the network operator.		

⑤①②⑤④	GSM RSSI		Disabled/Low/High
Set the minimum acceptable network signal level (RSSI level). Options: Disabled (No troubles for low signal reception) / Low signal / High signal			
⑤①②⑥	Prepay SIM		
Allows programming parameters that will be used when a prepaid SIM card is used in the system.			
⑤①②⑥①	Get Credit by		
Depending on the local network provider, the user can receive the credit level of the prepaid SIM card by sending a predefined SMS command to a defined number or by calling a predefined number through the voice channel. The activation of the credit request can be done by the Grand Master. <ul style="list-style-type: none"> • SMS Credit Message: Enter the message command as defined by the provider and the provider's phone number to which the credit level SMS message request will be sent. • Voice Credit: Enter the provider's phone number to which a call will be established. • Service Command: Enter the service command message as defined by the provider. 			
⑤①②⑥②	Phone To Send		
The provider's phone number to which the credit level SMS message request will be sent to or a call will be established, depending on the selection in the Get Credit by parameter.			
⑤①②⑥③	Phone To Receive		
The provider's telephone number from which an automatic SMS credit status message will be sent from.			
⑤①②⑥④	SMS Message		
When performing manual Credit Level check this message will be sent to the provider in order to receive the SIM card credit. The message is predefined (for example "BILL") by your service provider. * When using a service command this field is ignored.			

Communication → Method → IP

Quick Keys	Parameter	Default	Range
⑤①③	IP		
	The IP menu contains parameters for the communication of the system over the IP network.		
⑤①③①	IP Config		
	The IP menu contains parameters for the communication of the system over the IP network.		
⑤①③①①	Obtain IP		
	Defines automatically whether the IP address, which the LightSYS Plus refers to, is dynamic or static.		
⑤①③①①①	Dynamic IP		
	The system refers to an IP address provided by the DHCP.		
⑤①③①①②	Static IP		
	The system refers to a static IP Address.		
⑤①③①②	Panel Port		
	The LightSYS Plus Port address.		
⑤①③①③	Panel IP (Only for Static IP)		
	The LightSYS Plus static IP address		
⑤①③①④	Subnet Mask (Only for Static IP)		
	The subnet mask is used to determine where the network number in an IP address ends.		
⑤①③①⑤	Gateway (Only for Static IP)		
	The IP address of the local Gateway, which enables communication settings to other LAN segments. This address is the IP address of the router connected to the same LAN segment as the LightSYS Plus.		
⑤①③①⑥	DNS Primary (Only for Static IP)		
	The IP address of the primary DNS server on the network.		
⑤①③①⑦	DNS Secondary (Only for Static IP)		
	The IP address of the secondary DNS server on the network.		

⑤①③①⑧	WiFi Scan		
	Scans for Wi-Fi Network		
⑤①③①⑨	Add WiFi Net		
	Add Wi-Fi Network		
⑤①③①⑨①	Name		
	Add Wi-Fi Network Name		
⑤①③①⑨②	Security type		
	Add Wi-Fi Security type		
⑤①③①⑨③	Connect		
	Connect to the Wi-Fi		
⑤①③①①①①	WPS Button		
	Press the WPS button on the router to establish a connection. A “Successfully Connected” to network message will appear within 2 min.		
⑤①③②	Email		
	Allows programming parameters that enable the system to send e-mail messages following Follow Me events		
⑤①③②①	Mail Host	000.000.000.000	
	The IP address or the host name of the SMTP mail server.		
⑤①③②②	SMTP Port	00000	00000—65535
	The port address of the SMTP mail server		
⑤①③②③	Email Address		
	The e-mail address that identifies the system to the mail recipient.		
⑤①③②④	SMTP Name		
	A name identifying the user to the SMTP mail server. Its field can include up to 10 alphanumeric characters and symbols (!, &, ? etc.).		
⑤①③②⑤	SMTP Password		
	The password authenticating the user to the SMTP mail server. It can include up to 10 alphanumeric characters and symbols (!, &, ? etc.).		
⑤①③③	Host Name	Security System	Up to 32 Characters
	IP address or a text name used to identify the LightSYS Plus over the network. Default: Security System		

⑤①③④	MS Polling (Keep Alive)		
<p>The time period that the system will establish automatic communication (polling) with the monitoring station over the IP network, in order to check the connection. Three polling times can be defined: primary, secondary and backup. For each time period, define the number of units between 1–65535. Each unit represents a time frame of 10 seconds.</p>			
<p>Note When using the polling feature through IP, the MS channel parameter must be defined as IP only.</p>			
<p>The use of these time periods depends on the reporting order to the MS defined by the report split MS urgent parameter (see <i>MS Urgent</i>, page 183). The following table describes how the three MSs use the primary, secondary & backup time intervals in the various MS report split options:</p>			
MS report Urgent events	MS 1 Polling State	MS 2 Polling State	MS 3 Polling State
Do not call	N/A	N/A	N/A
Call 1 st	Primary	N/A	N/A
Call 2 nd	N/A	Primary	N/A
Call 3 rd	N/A	N/A	Primary
Call All	Primary	Primary	Primary
1 st Backup 2 nd	Primary	If (MS 1 is OK) Secondary else (MS#1 Fails) Backup	N/A
1 st Backup 2 nd 3 rd	Primary	If (MS#1 is OK) Secondary else (MS#1 Fails) Backup	If (MS#2 is OK) Secondary else (MS#2 Fails) Backup
1 st Backup 3 rd Call 2 nd	Primary	Primary	If (MS#1 is OK) Secondary else (MS#1 Fails) Backup
2 nd Backup 3 rd Call 1 st	Primary	Primary	If (MS#2 is OK) Secondary else (MS#2 Fails) Backup
<p>MS Polling example: When selecting MS 1 (IP Only), MS 2 (IP only) and split report option 1st Backup 2nd (using the default primary, secondary and backup time intervals), the report process will be as follows:</p>			

In a normal state:
 Polling through the IP network using the IP will occur every 30 seconds according to the primary time interval to MS 1 and every 3600 seconds (1 hour) according to the secondary time interval to MS 2.
 When communication to MS 1 fails, polling occurs every 30 seconds according to the backup interval to MS 2. When communication returns to MS 1, polling reverts back to the secondary time interval and occurs every 3600 seconds (1 hour) to MS#2

⑤ ① ③ ⑤	Controls	No	Yes/No
Enable or disable IP Communication			

Communication → Method → Radio (LRT)

Quick Keys	Parameter	Default	Range								
⑤①④	LRT (Long-Range Radio Transmission)										
	<p>The LRT menu contains parameters for setting a system long-range radio communication network, using the Location Aided Routing (LARS) protocol (LARS, LARS1, or LARS2) or E-LINE protocol to facilitate detailed event transmission to monitoring stations.</p>										
⑤①④①	Account	0	0—00FFFF								
	<p>The number that recognizes the customer at the monitoring station. You can define an account number for each monitoring station. These account numbers are the 6-digit numbers assigned by the monitoring station.</p> <p>Notes</p> <p>Account Number Communication Format:</p> <ul style="list-style-type: none"> The account number will always be reported as 4 digits, for example: A number defined as 000012 will be reported as 0012 The account range depends on which protocol is in effect, as follows: <table border="1"> <thead> <tr> <th>Protocol</th> <th>Range</th> </tr> </thead> <tbody> <tr> <td>LARS</td> <td>0000–7779 (First 3 digits: 0–7 only)</td> </tr> <tr> <td>LARS1</td> <td>0000–1FFF</td> </tr> <tr> <td>LARS2</td> <td>0000–FFFF</td> </tr> </tbody> </table> <p>If more than 4 digits were defined, the system always sends the last 4 digits of the account number, for example: Account number that was defined as 123456 will be sent as 3456.</p>			Protocol	Range	LARS	0000–7779 (First 3 digits: 0–7 only)	LARS1	0000–1FFF	LARS2	0000–FFFF
Protocol	Range										
LARS	0000–7779 (First 3 digits: 0–7 only)										
LARS1	0000–1FFF										
LARS2	0000–FFFF										
⑤①④②	System	0	LARS 0–3 LARS1 0–7 LARS2 0–F								
	<p>Use the one-digit system code to efficiently allocate transmitter reporting among monitoring stations.</p>										
⑤①④③	Periodic Test	00	HR: 00–96 MIN 00–59								
	<p>The Periodic Test enables you to set how often the system will automatically establish communication to the monitoring station in order to confirm operational functionality. The periodic test involves sending the account number and a valid test report code (Contact ID 602).</p>										

Quick Keys	Parameter	Default	Range
⑤①④④	No. Comm. Parameter	060	0—255
	Specify the timeout threshold for establishing communication between the LRT and bus, which upon being reached, triggers an event report to the monitoring station.		
⑤①④⑤	Control	060	0—255
	Control parameters		
⑤①④⑤①	Disable Low Battery	Y	Yes/No
	<p>YES: [For use when LRT is housed in the main LightSYS Plus box] LRT low battery trouble condition will not be regarded.</p> <p>NO: [For use when LRT is housed remotely in its own box] LRT low battery trouble condition will be regarded.</p>		

⑤② Monitoring Station

Define the following, which enable the system to establish communication with up to three monitoring station accounts:

- Report Type
- Accounts
- Communications Format
- Controls
- Parameters
- MS Timers
- Report Split
- Report Codes

Communication → Monitoring Station → Report Type

Quick Keys	Parameter
⑤②①	MS Mode
	Select to Enable or Disable the MS mode
⑤②①	Report Type ①
	Defines the communication type that the system will establish with each monitoring station account. The system can report in these (optional) communication channels: Voice, IP, SMS, LRT, SIA IP. NOTE: If there is a communication fault with the monitoring station the panel will not be ready to arm.
⑤②① ①–③	Select MS
	Scroll to select the monitoring station account (MS 1 – MS 3) for which you want to define the reporting type, and then press OK .
⑤②①①–③ ①–⑤	MS Channel
	Scroll to select the communication channel to use for reporting to the monitoring station account, and then press OK : ① Voice ② IP ③ SMS ④ LRT ⑤ SIA IP

Quick Keys	Parameter												
⑤②①①-③ ①	<p data-bbox="315 188 381 213">Voice</p> <p data-bbox="315 233 1028 352">Reports to the monitoring station will be done through the GSM network. Reporting by Voice can be established through different channels. The optional channels depend on the hardware installed in your system. Select the required channel:</p> <ol data-bbox="329 363 1028 528" style="list-style-type: none"> <li data-bbox="329 363 505 389">1. PSTN/GSM: <li data-bbox="329 400 505 426">2. GSM/PSTN: <li data-bbox="329 437 499 462">3. PSTN Only: <li data-bbox="329 474 1028 528">4. GSM Only: The outgoing calls are executed through the GSM audio channel only. <p data-bbox="315 539 378 564">Note</p> <p data-bbox="315 571 1028 724">Using the Voice (Contact ID or SIA) channel reporting to MS (Monitoring Station) may be unreliable due to the cellular provider network quality which can cause signal deviation and/or timing delays which affect meeting the Contact ID or SIA protocol constraints.</p> <p data-bbox="315 735 1042 799">Enter the monitoring station telephone number including area code and special characters (if required):</p> <table border="1" data-bbox="315 799 1055 1062"> <thead> <tr> <th data-bbox="315 799 815 831">Function</th> <th data-bbox="815 799 1055 831">Results</th> </tr> </thead> <tbody> <tr> <td data-bbox="315 831 815 871">Stop dialing and wait for a new dial tone</td> <td data-bbox="815 831 1055 871">W</td> </tr> <tr> <td data-bbox="315 871 815 911">Wait a fixed period before continuing</td> <td data-bbox="815 871 1055 911">,</td> </tr> <tr> <td data-bbox="315 911 815 951">Send the DTMF * character</td> <td data-bbox="815 911 1055 951">*</td> </tr> <tr> <td data-bbox="315 951 815 991">Send the DTMF # character</td> <td data-bbox="815 951 1055 991">#</td> </tr> <tr> <td data-bbox="315 991 815 1062">Delete numbers from the cursor position</td> <td data-bbox="815 991 1055 1062">[*] @ simultaneously</td> </tr> </tbody> </table>	Function	Results	Stop dialing and wait for a new dial tone	W	Wait a fixed period before continuing	,	Send the DTMF * character	*	Send the DTMF # character	#	Delete numbers from the cursor position	[*] @ simultaneously
Function	Results												
Stop dialing and wait for a new dial tone	W												
Wait a fixed period before continuing	,												
Send the DTMF * character	*												
Send the DTMF # character	#												
Delete numbers from the cursor position	[*] @ simultaneously												
⑤②①①-③ ②	<p data-bbox="315 1074 342 1099">IP</p> <p data-bbox="315 1118 1028 1303">Encrypted events are sent to the monitoring station over the IP or GPRS/3G/4G network using TCP/IP protocol. 128 BIT AES encryption is used. RISCO Group's IP/GSM Receiver Software located at the MS site receives the messages and translates them to standard protocols used by monitoring station applications (For example; contact ID).</p>												

Quick Keys	Parameter
	<p>Note</p> <p>To enable GPRS/3G/4G communication the SIM card has to support GPRS/3G/4G channel.</p> <p>Reporting by IP can be established through different channels. The optional channels depend on the hardware installed in your system. Select the required channel via the Configuration Software as follows:</p> <ol style="list-style-type: none"> 1. IP/GPRS: The panel checks for the availability of the IP network. During regular operation mode all calls and data transmission are carried out using the IP network line. In the case of trouble in the IP network, the report is routed to the GPRS/3G/4G network. 2. GPRS/IP: The panel checks for the availability of the GPRS/3G/4G network. During regular operation mode all calls and data transmission are carried out using the GPRS/3G/4G. In the case of trouble the report is routed to the IP network. 3. IP Only: The report is executed through the IP network only. 4. GPRS Only: The report is executed through the GPRS/3G/4G network. <p>Enter the relevant IP and Port numbers for the MS that will receive reports from the system (See IP and Port)</p>
<p>⑤ ② ① ① – ③ ③</p>	<p>SMS</p> <p>Enter the relevant phone numbers for the monitoring station that will receive reports from the system via encrypted SMS (see explanation in Voice type, above)</p> <p>Events are sent to the monitoring station using encrypted SMS messages (128 BIT AES encryption). Each event message contains information including the account number, report code, communication format, time of event and more. The event messages are received by RISCO's IP Receiver software located at the monitoring station site. The IP Receiver translates the SMS messages to standard protocols used by the monitoring station applications (For example; contact ID). This channel requires that RISCO Group's IP/GSM receiver has to be used at the MS side.</p>
<p>⑤ ② ① ④</p>	<p>LRT</p>

Quick Keys	Parameter
	The LRT menu contains parameters for setting a system long-range radio communication network, using the Location Aided Routing (LARS) protocol (LARS, LARS1, or LARS2) or E-LINE protocol to facilitate detailed event transmission to monitoring stations.
⑤ ② ① ⚙ ⑤	SIA IP
	<p>NOTE: ⚙ = monitoring station (MS) account</p> <p>Reports to the monitoring station can be transmitted using the SIA IP protocol to standard SIA IP receivers. Using SIA IP enables transmission of visual imagery from PIR cameras. Reporting by SIA IP can be established through the hardware channels installed in your system. Reporting of the SIA IP is 128 BIT AES encrypted. SIA IP reports also support labels reporting. Usage of SIA IP requires setting. See: ⑤ ② ⑤ ③</p> <ul style="list-style-type: none"> • Encryption Key • SIA IP Receiver Number • SIA IP Receiver Line Number

Communication → Monitoring Station → Accounts

Quick Keys	Parameter
⑤ ② ②	Accounts
	<p>The number that recognizes the customer at the monitoring station, you can define an account number for each monitoring station (1–3 possible). Account numbers are 6-digit numbers in length, and are assigned by the central station.</p> <p>➤ To edit an MS account number (code):</p> <ol style="list-style-type: none"> 1. From the installer Programming menu, go to: 5 → 2 → 2 2. Scroll to the MS account (①, ② or ③), and then press OK (✓). 3. Define/modify the code as needed, per the communication format notes below: <p>Notes</p> <p>Notes for Account Number in Contact ID Communication Format:</p> <ul style="list-style-type: none"> • The account number will always be reported as 4 digits, for example: A number defined as 000012 will be reported as 0012 • If more than 4 digits were defined, the system always sends the last 4 digits of the account number, for example: Account number that was defined as 123456 will be sent as 3456.

Quick Keys	Parameter
	<ul style="list-style-type: none"> In Contact ID you can place digits and letters A–F. The A character is always sent as 0 for example: Account number that was defined as 00C2AB will be sent as C20B. <p>Notes for Account Number in SIA Communication Format:</p> <ul style="list-style-type: none"> Account number for SIA should be defined as a decimal number (Only digits 0..9) Account number can be reported as 1 to 6 digits. To send an account number with less than 6 digits use the “0” digit, for example: For account number 1234 enter 001234. In this case the system will not send the “0” digit to the monitoring station. In order to send the “0” digit in SIA format, located at the left side of the number, use the “A” digit instead of the “0” digit. For example, for account number 0407 enter 00A407, for a 6 digit account number such as 001207 enter AA1207.
<p>⑤ ② ② ①</p>	<p>Partition (MS Accounts per Partition)</p> <p>You can specify the monitoring station account(s) to notify upon events that occur for the partitions you select (there are 32 partitions maximum per system).</p> <p>If you selected partition(s) from 1–3, you then choose the monitoring station account(s) to notify (1–3) for each, followed by entering the respective account numbers (codes).</p> <p>If you selected partition(s) from 4–32, you then enter the account numbers (codes); all monitoring station accounts will be automatically notified for events occurring in these partitions.</p> <p>➤ To designate MS accounts per partition:</p> <ol style="list-style-type: none"> From the installer Programming menu, go to: 5 → 2 → 2 (Communication → MS → Accounts) Scroll to 01)Partition, and then press OK (✓). Select a partition number and then press OK. [If you selected partition 1–3]: Scroll to the MS account (①, ② or ③), press OK, enter the MS account number (code), and press OK. [If you selected partition 4–32]: Enter the MS account number (code) and press OK. Repeat this procedure for all additional monitoring station accounts-per-partition designations <p>NOTE: Advanced configuration options are also available from the Configuration Software.</p>

Communication → Monitoring Station → Communications Format

Quick Keys	Parameter
⑤ ② ③	Communications Format
	Enables the system to communicate to the monitoring station.
	Note
	See <i>Appendix E: Library Voice Messages, page 245.</i>
	<p>① Contact ID: The system allocates Report Codes supporting Contact (Point) ID</p> <p>② SIA: The system allocates Report Codes supporting SIA (Security Industry Association) format</p>

Communication → Monitoring Station → Controls

Quick Keys	Parameter	Default	Range
⑤ ② ④	Controls		
	Programmable controls related to communication between the system and the monitoring station		
⑤ ② ④ ①	Call Save	No	Yes/No
	<p>YES: For reducing MS traffic congestion, the system holds all non-urgent events (for example, opening/closing reports, test transmissions) for up to 12 hours (programmable) and sends them as a batch at a less busy time, for example, at night (see <i>Periodic Test, page 180</i>).</p> <p>NO: All events are transmitted as they occur.</p>		
⑤ ② ④ ②	Show Kissoff	No	Yes/No
	<p>YES: The keypad indicates when the dialer receives the kissoff signal from the MS's receiver.</p> <p>NO: The keypad does not indicate on receipt of the kissoff signal.</p>		
⑤ ② ④ ③	Show Handshake	No	Yes/No
	<p>YES: The keypad indicates when the dialer receives the handshake signal from the monitoring station's receiver.</p> <p>NO: No indication for establishing communication with the MS's receiver</p>		

Quick Keys	Parameter	Default	Range
⑤②④④	Audible Kissoff	No	Yes/No
	<p>YES: There is an audible sound emitted from the keypad when the dialer receives the kissoff signal from the monitoring station's receiver.</p> <p>NO: There is no audible sound on receipt of the kissoff signal.</p>		
⑤②④⑤	SIA Text	No	Yes/No
	<p>Yes: SIA format report to monitoring station will support text transmission over the voice channel.</p> <p>Note</p> <p>The monitoring station receiver should support the SIA Text protocol</p> <p>No: SIA format will not support text</p>		
⑤②④⑥	Random MS Testing	No	Yes/No
	<p>Yes: At power-up the panel randomly set a test time between 00:00 and 23:59. Once the hour is set, this will be the fixed report hour of this panel. The time can be viewed under the Periodic test timer fields (⑤②⑥①). The interval of sending the test will be as defined under the Periodic Test timer</p> <p>No: The periodic test will be according to the time defined under the MS periodic timer (⑤②⑥①).</p>		
⑤②④⑦	SIA W/Partition	No	Yes/No
	<p>Indicates the partition when reporting to the monitoring station in SIA over the voice channel (GSM).</p> <p>Yes: SIA format report to MS will support text transmission over the voice channel.</p> <p>Note</p> <p>The monitoring station receiver should support the SIA Text protocol</p> <p>No: SIA format will not support text</p>		
⑤②④⑧	SIA CH Info	No	Yes/No
	<p>When the panel transmits events to the monitoring station, additional MS channel type information (whether by IP or GPRS) is provided with the transmitted event.</p> <p>Yes: Additional MS channel type information is provided with the transmitted event.</p> <p>No: Additional MS channel type information is not provided with the transmitted event.</p>		

Quick Keys	Parameter	Default	Range
⑤②⑤	Parameters		
	Programmable parameters related to operation with the MS		
⑤②⑤①	MS Retries	08	01 – 15
	<p>The number of times the LightSYS Plus redials the monitoring station after failing to establish communication.</p> <p>NOTE: If there is a communication fault with the monitoring station the panel will not be ready to arm.</p>		
⑤②⑤②	Alarm Restore		
	<p>Specifies under what conditions an Alarm Restoral is reported. This option informs the MS of a change in the specified condition(s) during an alarm restore. These reports need a valid Report Code.</p> <p>① ON BTO (Bell Time Out) – Reports the restoral after the audible alarm times out.</p> <p>② FOLLOW ZONE – Reports the restoral when the zone in which the alarm occurs returns to its non-violated (secured) state.</p> <p>③ AT DISARM – Reports the restoral when system (or the partition in which the alarm occurs) is disarmed, even if the siren has timed out.</p>		
⑤②⑤③	SIA IP Param.		
	<p>Define the following SIA IP parameters for each monitoring station account (MS1, MS2, and MS3):</p> <p>1) Encryption Key</p> <p>2) Receiver Number</p> <p>3) Line Number</p>		
	<p>① Encryption Key</p> <p>A 32-digit digital signature and authentication for purposes of safeguarding data transmission to and from the monitoring station. The key must be defined for both the panel and monitoring station. For use when SIA IP report type is in effect. A unique key can be defined for each of up to three monitoring stations.</p>		
	<p>② Receiver Number</p> <p>A 4 digit number which states the SIA IP receiver number as supplied from the monitoring station. A unique key can be defined for each of up to three monitoring stations.</p>		
	<p>③ Line Number</p> <p>A 4 digit number which states the SIA IP receiver line number as supplied from the monitoring station. A unique key can be defined</p>		

Quick Keys	Parameter	Default	Range
	for each of up to three monitoring stations.		

Communication → Monitoring Station → MS Timers

Quick Keys	Parameter	Default	Range
⑤ ② ⑥	MS Times		

Allows programming timers related to operation with the monitoring station.

⑤ ② ⑥ ①	Periodic Test		HR = 0--24 MIN = 0—59 D = per table below
---------	----------------------	--	---

The Periodic Test enables you to set the time period that the system will automatically establish communication to the monitoring station in order to check the connection. The periodic test involves sending the account number and a valid test report code (Contact ID 602, SIA TX). Set the test time and daily interval for Periodic Test Reporting.

Use the table below to specify the daily testing intervals (D)-effective from the day of programming:

D	Meaning
0	Never
H	Every hour
1	Every day
2	Every other day
3	Every 3 rd day
4	Every 4 th day
5	Every 5 th day
6	Every 6 th day
7	Once a week

Quick Keys	Parameter	Default	Range
⑤②⑥②	Abort Alarm	15 secs	00-255 seconds
	Defines the time delay before reporting an alarm to the monitoring station. If the alarm system is disarmed within the abort window, no alarm transmission shall be sent to the monitoring station.		
⑤②⑥③	Cancel Delay	5 mins	00-255 minutes
	If an alarm is sent in error, it is possible for the monitoring station to receive a cancel alarm code, sent subsequently to the initial alarm code. This happens if a valid user code is entered to reset the alarm in the cancel delay time window that starts after the defined abort alarm time is over.		
	Note Ensure that Cancel Alarm report code is defined.		
⑤②⑥④	Listen In	120 sec	1-255 seconds
	The time duration for the monitoring station to listen in and perform voice alarm verification. After this period the system hang up the line. The monitoring station can expand the listen in time during the conversation by pressing the digit "1" on the telephone (for a repeatable two minute extension). In this case, the Listen In time will reset and start over again. Pressing "2" during Listen In time will switch to Talk mode. Pressing "*" during Listen In time will end the call.		
⑤②⑥⑤	Confirmation		
	These confirmation times relate to the zone's sequential confirmation (see ②④) - <i>Alarm Confirm, page 141</i>).		
⑤②⑥⑤①	Confirm Start (Confirm delay time)	000	1 – 120 minutes
	Specifies that the system cannot start a sequential confirmation process until the timer has expired. This time starts when the system has been armed and will prevent confirmed alarms being generated in situations when a person has been accidentally locked in the building.		

Quick Keys	Parameter	Default	Range
⑤ ② ⑥ ⑤ ②	Confirm Time (Confirmation Time Window)	030	30—60 minutes
<p>Specifies a time period that starts when an intrusion alarm is triggered for the first time. If a second intrusion alarm is triggered before the end of the time period (the "confirmation time window"), the system will then send a "confirmed" alarm notification to the monitoring station.</p>			

Communication → Monitoring Station → Report Split

Quick Keys	Parameter	Default	Range
⑤ ② ⑦	Report Split		
<p>The Report Split menu contains parameters that enable the routing of specified events to up to three monitoring station (MS) receivers.</p>			
⑤ ② ⑦ ①	MS Arm/Disarm	1st backup 2nd	
<p>Reports Arming/Disarming (meaning Closings/Opening) events to the monitoring station (MS):</p> <ul style="list-style-type: none"> ① Do not call (no report). ② Call 1st: Reports Openings and Closings to MS 1. ③ Call 2nd: Reports Openings and Closings to MS 2. ④ Call 3rd: Reports Openings and Closings to MS 3. ⑤ Call all: Reports Openings and Closings to the all defined MS. ⑥ 1st Backup 2nd: Reports Openings and Closings to MS 1. If communication is not established, calls MS 2. ⑦ 1st Backup 2nd 3rd: Reports to MS 1. If communication is not established calls MS 2. If communication is not established again calls the MS. ⑧ 1st Backup 3rd Call 2nd: Reports MS 1. If communication is not established calls to MS 3. In addition it will also call MS 2. ⑨ 2nd Backup 3rd Call 1st: Reports to MS 2. If communication is not established calls MS 3. In addition it will also call MS 1. 			

Quick Keys	Parameter	Default	Range
<p>⑤ ② ⑦ ②</p>	<p>MS Urgent</p>	<p>1st backup 2nd</p>	<p>Reports urgent (alarm) events to the monitoring station (MS):</p> <ul style="list-style-type: none"> ① Do not call (no report) ② Call 1st: Reports Openings and Closings to MS 1. ③ Call 2nd: Reports Openings and Closings to MS 2. ④ Call 3rd: Reports Openings and Closings to MS 3. ⑤ Call all: Reports Openings and Closings to the all defined MS. ⑥ 1st Backup 2nd: Reports Openings and Closings to MS 1. If communication is not established, calls MS 2. ⑦ 1st Backup 2nd 3rd: Reports to MS 1. If communication is not established calls MS 2. If communication is not established again calls the MS. ⑧ 1st Backup 3rd Call 2nd: Reports MS 1. If communication is not established calls to MS 3. In addition it will also call MS 2. ⑨ 2nd Backup 3rd Call 1st: Reports to MS 2. If communication is not established calls MS 3. In addition it will also call MS 1.
<p>⑤ ② ⑦ ③</p>	<p>MS Non Urgent</p>		<p>Reports non-urgent events (supervisory troubles and test reports) to the monitoring station (MS):</p> <ul style="list-style-type: none"> ① Do not call (no report) ② Call 1st: Reports Openings and Closings to MS 1. ③ Call 2nd: Reports Openings and Closings to MS 2. ④ Call 3rd: Reports Openings and Closings to MS 3. ⑤ Call all: Reports Openings and Closings to the all defined MS. ⑥ 1st Backup 2nd: Reports Openings and Closings to MS 1. If communication is not established, calls MS 2. ⑦ 1st Backup 2nd 3rd: Reports to MS 1. If communication is not established calls MS 2. <p>If communication is not established again calls the MS.</p> <ul style="list-style-type: none"> ⑧ 1st Backup 3rd Call 2nd: Reports MS 1. If communication is not established calls to MS 3. In addition it will also call MS 2. ⑨ 2nd Backup 3rd Call 1st: Reports to MS 2. If communication is not established calls MS 3. In addition it will also call MS 1.

Communication → Monitoring Station → Report Codes

Quick Keys	Parameter	Default	Range
⑤②⑧	Report Codes		
	<p>Enables you to view or program the codes transmitted by the system to report events (for example, alarms, troubles, restores, supervisory tests, and so on) to the monitoring station.</p> <p>The codes specified for each type of event transmission are a function of the central station's own policies. Before programming any codes, it is important to check the central station protocols. Reporting codes are assigned by default, according to the selected communication format SIA or contact ID.</p> <p>Assigns a specified report code for each event, based on the reporting format to the monitoring station. An event that is not assigned with a report code will not be reported to the monitoring station. For list of report events see <i>Monitoring Station Report Codes</i>, page 246.</p> <p>NOTE: Using a double-zero (00) for any event will prevent a report from being generated.</p>		
⑤②⑧①	Edit Codes		
	For each code type, edit their respective parameters as needed.		
⑤②⑧①①	Alarms		
⑤②⑧①①①	Panic		
⑤②⑧①①②	Fire		
⑤②⑧①①③	Medical		
⑤②⑧①①④	Duress		
⑤②⑧①①⑤	Confirm Alarm		
⑤②⑧①①⑥	Box Tamper		
⑤②⑧①①⑦	Bell Tamper		
⑤②⑧①①⑧	Recent close		
⑤②⑧①①⑨	HU Confirm		
⑤②⑧①②	Main Troubles		
	Common system trouble parameters.		
⑤②⑧①②①	Low Battery		

Quick Keys	Parameter	Default	Range
⑤②⑧① ②②	Bell		
⑤②⑧① ②③	Phone trouble		
⑤②⑧① ②④	AC Loss		
⑤②⑧① ②⑤	AUX		
⑤②⑧① ②⑥	Clk Not Set		
⑤②⑧① ②⑦	Bus Trouble		
⑤②⑧① ②⑧	False Code		
⑤②⑧① ②⑨	GSM Trouble		
⑤②⑧① ②10	IP Net Trbl		
⑤②⑧① ②11	MS 1 Trouble		
⑤②⑧① ②12	MS 2 Trouble		
⑤②⑧① ②13	MS 3 Trouble		
⑤②⑧① ③	Arm/Disarm		
Set arming/disarming parameters.			
⑤②⑧① ③①	User		
⑤②⑧① ③②	Automatic		
⑤②⑧① ③③	Remote		
⑤②⑧① ③④	Force Arm		
⑤②⑧① ③⑤	Quick Arm		
⑤②⑧① ③⑥	Keyswitch		
⑤②⑧① ③⑦	Auto Arm Fail		
⑤②⑧① ④	Zones		
Set zone-related parameters.			
⑤②⑧① ④①	By Zone		
⑤②⑧① ④②	Zone Lost		

Quick Keys	Parameter	Default	Range
⑤②⑧①④③	Soak Fail		
⑤②⑧①④④	Self Test		
⑤②⑧①⑤	Accessories		
Edit parameters for system peripheral devices/accessories.			
⑤②⑧①⑤①	Keypad		
⑤②⑧①⑤②	Zone Expander		
⑤②⑧①⑤③	Util. Output		
⑤②⑧①⑤④	Power supply		
⑤②⑧①⑤⑤	Keyfob		
⑤②⑧①⑤⑥	Voice Module		
⑤②⑧①⑤⑧	WL Expander		
⑤②⑧①⑤⑨	Bus Expander		
⑤②⑧①⑤⑩	COB		
⑤②⑧①⑥	Miscellaneous		
Edit codes and other miscellaneous parameters			
⑤②⑧①⑥①	Enter Prog.		
⑤②⑧①⑥②	Exit Prog.		
⑤②⑧①⑥③	MS Periodic Test		
⑤②⑧①⑥④	System Reset		
⑤②⑧①⑥⑤	Abort Alarm		
⑤②⑧①⑥⑥	Listen In		
⑤②⑧①⑥⑦	MS Polling		
⑤②⑧①⑥⑧	Cancel Rprt.		
⑤②⑧①⑥⑨	Walk test		
⑤②⑧①⑥⑩	Exit Error		

Quick Keys	Parameter	Default	Range
⑤②⑧①⑥11	Fail Cloud		
⑤②⑧①⑥12	Entry Service Mode		
⑤②⑧①⑥13	Exit Service Mode		
⑤②⑧②	Delete All		
Clears all codes (reverts to factory defaults)			

⑤③ Configuration SW

Configure the following parameters for communication between the Configuration Software and the system:

- Security
- Controls
- Gateway

Communication → Configuration SW → Security

Quick Keys	Parameter	Default	Range
⑤③①	CS Mode		
Select to Enable or Disable CS Mode			
⑤③①	Security		
Enables you to set parameters for remote communication between the technician and the system using the Configuration Software			
⑤③①①	Access Code	5678	
<p>Enables you to define an up-to six-alpha-numeric-character installation access code.</p> <p>In order to enable communication between the alarm company and the system the same access code must subsequently be entered into the corresponding account profile created for the installation in the Configuration Software.</p> <p>For successful communication, the access code along with the ID code must match between the Configuration Software and the system.</p>			

Quick Keys	Parameter	Default	Range
⑤③①②	Remote ID	0001	
<p>Defines an ID code that serves as an extension of the access code. In order to enable communication between the alarm company and the installation, the same remote ID code must be entered into the account profile in the Configuration Software.</p> <p>For successful communication, the ID code along with the access code must match between the Configuration Software and the main panel.</p> <p>Dealers often use the customer's monitoring station account number for the ID code, but you can use any 4-digit code unique to the installation.</p>			
⑤③①③	MS Lock	000000	
<p>MS Lock is a security function used in conjunction with the Configuration Software. It provides greater proprietary security when viewing monitoring station parameters.</p> <p>The same 6-digit code, which will be stored in the panel, must be entered into the corresponding account profile created for the installation in the Configuration Software.</p> <p>If there is no match between the MS Lock code defined in the main panel and the MS Lock code defined in the Configuration Software, the installer will not have permission to change the following monitoring station parameters from the Configuration Software:</p> <p>MS Lock, Installer Code, MS IP Port, MS IP Address, MS Phone, Default Enable, MS Account, MS Format, MS Channel, MS Backup, MS Enable, Remote ID, Access Code.</p>			

Communication → Configuration SW → Controls

Quick Keys	Parameter	Default	Range
⑤③③	Control		
⑤③③①	User Initiated Call	Yes	Yes/No
<p>YES: For a remote Configuration Software session to take place, the Grand Master must first enter specific keypad commands in the User Functions mode.</p> <p>NO: Configuration Software operations are possible without requiring the user's participation.</p>			

Communication → Configuration SW → Gateway

Quick Keys	Parameter	Default	Range
⑤③④	IP Gateway		
	<p>The IP and port address of the configuration's software PC. If you have a router connected to the PC of the Configuration Software, then you should enter the IP of the router.</p> <p>This definition will be used when there is a request to create a remote connection from the panel to the Configuration Software. The connection can be done over IP or GPRS/3G/4G.</p> <p>Note In the configuration software, under Communication → Configuration → GPRS, enter the IP address of the PC that the software is installed in.</p>		
⑤③④①	IP Address		
⑤③④②	IP Port		

⑤④ Follow Me

In addition to reporting to the monitoring station, the Follow-Me feature enables reporting system events to pre-defined follow me user destinations using a voice message, SMS message or E-mail. Up to 64 Follow Me destinations can be defined in the system. The following FM parameters can be defined:

- **Define FM**
- **Controls**
- **Parameters**

Note

If FM is enabled and no voice module is installed then “beeps” will be sent instead of messages.

Communication → Follow Me → Define FM

Quick Keys	Parameter	Default	Range
⑤④①	FM Mode		
	Select to enable or disable Follow Me mode		
⑤④①	Define FM		
	Up to 64 Follow Me destinations can be defined in the system. Select a follow destination from the list		

Quick Keys	Parameter	Default	Range
⑤④①⊛①	Report Type		
	<p>Defines the type of reporting events to a Follow Me destination. NOTE: ⊛ = FM number</p>		
⑤④①⊛①①	Voice		
	<p>Report to follow me will be done by voice message through the GSM network. Enter the telephone number including area code or special letters for Follow Me defined as SMS or Voice.</p> <p>Reporting events by Voice can be established through different channels. The optional channels depend on the hardware installed in the system. Select the required channel as follows:</p> <ul style="list-style-type: none"> ① PSTN/GSM: ② GSM/PSTN: ③ PSTN Only: ④ GSM Only: The outgoing calls are executed through the GSM audio channel only. 		
⑤④①⊛①②	EMAIL		
	<p>Report to Follow Me will be done by e-mail thorough IP or GPRS/3G/4G (or GSM – depending which modules are installed). Each e-mail contains information including the system label. Event type and time. Enter the e-mail address for Follow Me destination defined as IP type.</p> <ul style="list-style-type: none"> ① IP/GPRS (or IP/GSM): The system checks for the availability of the IP network. During regular operation, emails will be sent using the IP network line. In case of trouble in the IP network, the email is routed to the GPRS/3G/4G network. ② GPRS/IP (or GSM/IP): The system checks for the availability of the GPRS/GSM network. During regular operation mode emails will be sent using the GPRS/3G/4G/GSM. In case of trouble, the email is routed to the IP network. ③ IP Only: The report is executed through the IP network only ④ GPRS Only (or GSM Only): The report is executed through the GPRS/3G/4G/GSM network only 		
⑤④①⊛①③	SMS		
	<p>Report to Follow Me will be done by SMS. Each event message contains information including the system label, event type and time. Enter the telephone number including area code or special letters.</p>		

Quick Keys	Parameter	Default	Range
⑤④①★②	Partition		
	Assign the partitions from which events will be reported to the Follow Me number.		
⑤④①★③	Events		
	Each Follow Me destination can be assigned with its own set of events. Choose the events that will be reported to each Follow Me		
	Event	Description	Default
	① Alarms		
	① Intruder	Intruder alarm in the system	Yes
	② Fire	Fire alarm in the system	Yes
	③ Emergency	Emergency alarm in the system	Yes
	④ Panic (S.O.S)	A panic alarm in the system	Yes
	⑤ Tamper	Any tamper alarm in the system	No
	⑥ Duress Alarm	Duress alarm in the system from user xx	Yes
	⑦ Confirmed alarm	Confirmed alarm indication	No
	② Arm/Disarm		
	① Arm	Arming operation has been performed in the system	No
	② Disarm	Disarming operation has been performed in the system	No
	③ Troubles		
	① False Code	After three unsuccessful attempts of entering an incorrect code.	No
	② Main Low Battery	Low battery indication from the LightSYS Plus main panel (below 11V)	No
	③ Wireless Low Battery	Low battery indication from any wireless device in the system	No
	④ Jamming	Jamming indication in the system	No
	⑤ WL Lost	Wireless device lost. When no supervision signal is received from a wireless device	No
	⑥ AC Off	Interruption in the source of the main AC power. This activation will follow the delay time predefined in the AC Loss Delay timer	No
	⑦ Bell Trouble	Bell trouble in the system	
	⑧ Bus Trouble	Bus trouble in the system	

Quick Keys	Parameter	Default	Range
	0 9 Siren low Battery	Low battery indication from any sounder in the system	
	1 0 PSTN Trouble	PSTN lost event. If PSTN Loss Delay time period is defined, the message will be sent after the delay time	No
	1 1 IP Network	Communication trouble with the IP network.	No
④ GSM			
	1 GSM Trouble	General GSM trouble (Network availability, Network Quality, PIN code error, Module communication, GPRS/3G/4G password, GPRS/3G/4G IP fault, GPRS/3G/4G Connection, PUK code fault	No
	2 SIM Trouble	Any trouble with the SIM card	No
	3 SIM Expire	Report to Follow Me will be established 30 days before the SIM Expiration Time defined for a prepaid SIM card.	No
	4 SIM Credit	An automatic SMS credit message (or any other message) received from the provider's number predefined in SMS Receive Phone will be transferred to the Follow Me number	No
⑤ Environmental			
	1 Gas Alert	Gas (natural gas) alert from a zone defined a Gas detector	No
	2 Flood Alert	Flood alert from a zone defined as flood type	No
	3 CO Alert	CO (Carbon Monoxide) alert from a zone defined a CO detector	No
	4 High Temperature	High Temperature alert from a zone defined a Temperature detector	No
	5 Low Temperature	Low Temperature alert from a zone defined a Temperature detector	No
	6 Technical	Alert from the zone defined as Technical	No
⑥ Miscellaneous			
	1 Zone Bypass	Zone has been bypassed	No
	2 Periodic test	Follow Me test message will be established following the time defined in the Periodic Test parameter under the MS parameters	No

Quick Keys	Parameter	Default	Range
	3 Remote programming	System is in remote installation mode	No
Quick Keys	Parameter	Default	Range
5 4 1 3 4	Restore Events		
Choose the restore events that will be reported to each Follow Me destination.			
Event	Description	Default	
1 Alarms			
0 1 Intruder Alarm	Intruder alarm in the system restored	Yes	
0 2 Tamper	Tamper alarm in the system restored	No	
2 Troubles			
0 1 Main Low Battery	Low battery indication from the LightSYS Plus main panel restored	No	
0 2 WL Low Battery	Low battery indication from any wireless device in the system restored	No	
0 3 Jamming	Jamming indication in the system restored	No	
0 4 WL Lost	Wireless device lost restored	No	
0 5 AC Off	Interruption in the source of the main AC power restored	No	
0 6 Bell Trouble	Bell trouble restored		
0 7 Bus trouble	Bus trouble restored		
0 8 Siren low Battery trouble	Siren low Battery trouble restored		
0 9 PSTN Trouble	PSTN lost event restored	No	
1 0 IP Network	Communication trouble in the IP restored	No	
3 GSM			
1 GSM Trouble	General GSM trouble restored	No	
4 Environmental			
1 Gas Alert	Gas Alert restored	No	
2 Flood Alert	Flood Alert restored	No	
3 CO Alert	CO Alert restored	No	
4 High Temperature	High Temperature Alert restored	No	
5 Low Temperature	Low Temperature Alert restored	No	

Quick Keys	Parameter	Default	Range
	⑥ Technical	Technical Alert restored	No
Quick Keys	Parameter	Default	Range
⑤④①★⑤	Remote Control		Yes/No
⑤④①★⑤①	Remote Listen	No	Yes/No
	Enables the user of the Follow Me phone to perform remote listen and talk operation with the premises.		
⑤④①★⑤②	Remote program	No	Yes/No
	Enables the user of the Follow Me phone to enter the remote operation menu and perform all available programming options. For more details see the LightSYS Plus User Manual.		

Communication → Follow Me → Controls

Quick Keys	Parameter	Default	Range
⑤④②	Controls		
	Programmable controls related to Follow Me operation		
⑤④②①	Disarm Stop Follow Me	Yes	Yes/No
	YES: The Follow-Me reports will stop when the partitions are disarmed by a user code NO: The Follow-Me reports will continue to be made when the partitions are disarmed by a user code		
⑤④②②	Disable Report at Stay	No	Yes/No
	YES: No follow me report during partial (Stay) or Group arming for alarm or tamper NO: Follow Me report for alarm or tamper will be established during partial (Stay) arming.		

Communication → Follow Me → Parameters

Quick Keys	Parameter	Default	Range
⑤④③	Parameters		
Allows to program parameters related to operation with the Follow Me			
⑤④③①	Follow Me Retries	03	01—15
Edit the number of times the Follow Me phone number is redialed			
⑤④③②	Voice Message Recurrence	01	01—05
Edit the number of times a voice message repeats itself when establishing a call to a Follow Me number			
⑤④③③	Follow Me Periodic Test		(see <i>Periodic Test</i> , page 180).
Set the time period that the system will automatically establish communication to a Follow Me destination defined with the Periodic Test event (see <i>Periodic Test</i> , page 180).			

⑤⑤ Cloud

Define the following parameters for Cloud communication:

Communication → Cloud

Quick Keys	Parameter	Default	Range
⑤⑤	Cloud		
Define here the server settings for communication with the LightSYS Plus system. NOTE: For Cloud connectivity, Cloud must be enabled (default). To enable/disable Cloud connectivity go to: 1)System → 2)Controls → 3)Communication → 4)Cloud Enable and then select Y (yes) to enable or N (no) to disable.			
⑤⑤①	IP Address	www.riscocloud.com	
The IP address or server name. If the LightSYS Plus system is connected to the RISCO Cloud for self-monitoring, then use: riscocloud.com. Otherwise enter the IP address or name where the private Cloud server is located.			
⑤⑤②	IP Port	33000	
The server port address			

Quick Keys	Parameter	Default	Range
⑤ ⑤ ③	Password	AAAAAA	Up to 6 characters (case sensitive)
Specify the password for server access. This password should be identical to the CP Password defined in the server under the Control Panel Page definition.			
⑤ ⑤ ④	Channel		
<p>Communication with the Cloud can be established through an IP or GSM channel, depending on your system installed hardware.</p> <p>Utilizing the standard single-channel communication modules, communication with the Cloud can be established through an IP or GSM channel, depending on the installed system hardware.</p> <p>Utilizing the generation multi-socket communication modules, communication with the Cloud can be established with either the IP or GSM 2G / 3G modules.</p> <p><u>Available Communication Options:</u></p> <ul style="list-style-type: none"> • IP Only: Communication is executed through the IP network only. • GSM (or GPRS) Only: Communication is executed through the GSM or GPRS/3G/4G network only • IP/GSM: Communication is executed through the IP network (primary channel) or through the GSM network (backup channel) • GSM/IP: Communication is executed through the GSM network (primary channel) or through the IP network (backup channel) 			

Quick Keys	Parameter	Default	Range
⑤ ⑤ ⑤	Controls		01-05
	<p>The LightSYS Plus supports parallel channel reporting (via IP, GPRS, GSM, SMS, or voice) to both the monitoring station and FM when connected in Cloud mode. Use this setting to decide if the panel reports events to the monitoring station or Follow-Me in parallel to the report to the Cloud or only as a backup when the communication between the LightSYS Plus and the Cloud is not functioning.</p> <p>NOTE: When the backup mode is functioning, the monitoring station specifications are as defined under MS menu (see <i>Monitoring Station, page 172 and Follow Me, page 189</i>).</p>		
	① MS Call All		
	<p>YES: Parallel reporting to the MS can be established via both the Cloud and non-Cloud channels.</p> <p>NO: Communication to the Monitoring station via the non-Cloud channels can be established only in backup mode (when LightSYS Plus – Cloud connection is down)</p>		
	② FM Call All		
	<p>YES: Parallel reporting to the Follow Me destination can be established via both the Cloud and non-Cloud channels.</p> <p>NO: Communication to the Follow Me destination via the non-Cloud channels can be established only in backup mode (when LightSYS Plus – Cloud connection is down)</p>		
	③ App Arm		
	<p>Yes: Enables remote system arming from user app and Web user interface</p> <p>No: Disables remote system arming from user app and Web user interface</p>		
	④ App Disarm		
	<p>YES: Enables remote system disarming from user app, Web user interface</p> <p>NO: Disables remote system disarming from user app, Web user interface</p>		
	⑤ App Exit Delay		
	<p>YES: Enables remote Exit Delay from user app, Web user interface</p> <p>NO: Disables remote Exit Delay from user app, Web user interface</p>		
	⑥ Encryption		
	<p>YES: Enables encrypted communication with the cloud</p> <p>NO: Disables encrypted communication with the cloud</p>		

⑥ Audio

The following Audio menus are used to define voice message parameters:

- Messages
- Local Announcements

Note

This menu will be displayed only if a Voice module had been assigned to the system

⑥① Messages

Audio → Messages

Quick Keys	Parameter	Default	Range
⑥①	Messages		
<p>Use this menu to customize the spoken messages of Zones, Partitions, Outputs, Macro's and Opening Message that the Voice module announces when you access the system from a remote telephone or you hear on the premises. There are 2 ways to customize a voice message:</p> <ol style="list-style-type: none"> 1. User recorded: The ① Common Message and the ⑥ Library Messages are user recorded messages. The recording can be done either from the microphone located on the voice module expander or from a microphone located on the Listen-In & Speak unit. 			
<p>Note The definition of which microphone to use is determined by dip switch 4 located on the voice module board.</p>			
<ol style="list-style-type: none"> 2. Assign messages: The Zone / Partition/ Output and Macro messages can be assigned with pre-recorded messages. Each message can be comprised of up to 4 words. Each word has been pre-recorded and assigned a number. When comprising a message the installer will enter the number of each word into the message sequence. The system recognizes the numbers and sounds the words assigned to those numbers. For example: For the system to sound “Top Floor Guest Bedroom”, you should enter the following sequence: 119 050 061 019. The table in <i>Appendix E</i>: 3. <i>Library Voice Messages, page 245</i> displays the directory of the pre-recorded programming descriptors, each is identified by a 3 digit number. 			
<p>Note The first five descriptors allow for customized words specific for the client's needs. The customized words are the Library message on option ⑥ After recording or assigning a message you can verify messages by selecting [1] Play option in each category.</p>			

⑥ ① ①	Common Message	
<p>User-defined identification of the premises, for example, the address and/or telephone number of the premises. This message is up to 10 seconds long. The default Common message is “Hello, this is your security system calling”</p>		
⑥ ① ②	Zone	
<p>User-defined name for the zone in which the event occurred. The Zone message can be up to 2 seconds long, and is only announced when the Event announcement message concerns a zone.</p>		
⑥ ① ③	Partition	
<p>User-defined name for the partition in which the event occurred. The partition message can be up to 2 seconds long.</p>		
⑥ ① ④	Output	
<p>Assign descriptive and distinguishing voice messages for utility outputs</p>		
⑥ ① ⑤	Macro	
<p>Assigning a voice message to a macro simplifies the meaning of the macro operation for the user.</p>		
⑥ ① ⑥	Library	
<p>User-defined messages for customer needs. Each library message is self-recorded and can be up to 2 seconds long.</p>		

⑥② Local Announcements

Audio → Local Announcements

Quick keys	Parameter	Default	Range
⑥②	Local Announcement		
	<p>Upon event occurrence, the system can announce the security situation to occupants of the premises by sounding a local announcement message from the add-on Listen-In & Speak unit. This announcement message can be enabled or disabled (by toggling to Y or N) per event. Enable or disable each of the following message announcements according to your customer request.</p>		
Announcement	Description	Default	
①① Intruder alarm	Intruder alarm	Yes	
①② Fire alarm	Fire alarm	Yes	
①③ Emergency	Emergency (medical) alarm	Yes	
①④ Panic alarm	Panic alarm	Yes	
①⑤ Tamper alarm	Tamper alarm	Yes	
①⑥ Environmental alert	Flood, Gas, CO or Temperature alert	Yes	
①⑦ Away arm	System/Partition armed in Away (Full) arm	Yes	
①⑧ Stay arm	System/Partition armed in Stay(Partial) arm	Yes	
①⑨ Disarm	System/Partition disarmed	Yes	
①⑩ Audible Status	Status heard when pressing the status button on the keypad/remote control	Yes	
①① Entry / Exit	System in exit or entry delay	Yes	
①② Auto arm	System in auto arm process	Yes	
①③ Output	Output activated or deactivated	No	
①④ Walk test	Walk test. The LightSYS Plus will sound the zone number and description	Yes	

⑦ Install

The following enable adding, removing or testing accessories in the system:

- **Bus Devices**
- **Wireless Device**

⑦① Bus Devices

The Bus Device sub-menu provides access to the following:

- **Automatic**
- **Manual**
- **Testing**
- **Bus speed**

Install → Bus Devices → Automatic

EN 50131-3 Note

The automatic setting/unsetting function (Auto Settings) is not in compliance with EN50131-3

Quick Keys	Parameter	Default	Range
⑦①①	Automatic		
<p>This menu enables you to perform an automatic "Auto Settings" bus scan in order to recognize, enable (allocate), and perform on-the-fly configuration for all bus devices connected in the system. See <i>Auto-Setting Scan for Communication Modules & Bus Devices</i>, page 53 and <i>Bus Scan (Auto Setting)</i> on page 204.</p>			

Install → Bus Devices → Manual

Quick Keys	Parameter	Default	Range
⑦①②	Manual		
<p>Use this option to manually add or remove bus devices and set parameters.</p> <p>Notes</p> <ul style="list-style-type: none"> • Make sure that the bus device's physical ID number has been "dip switch" programmed • Non-partitioned systems are regarded as Partition 1. • In partitioned systems, keypads can be selectively assigned to specific partitions 			
⑦①② ①①	Keypads (wired)		
<p>See <i>Manually Allocating & Configuring other Modules and Bus Devices → Wired Keypads</i>, page 57.</p>			
⑦①② ①②	Zone Expander		
<p>See <i>Manually Allocating & Configuring other Modules and Bus Devices → Zone Expanders</i>, page 58.</p>			
⑦①② ①③	Utility Output		
<p>See <i>Manually Allocating & Configuring other Modules and Bus Devices → Utility Output Modules</i>, page 58.</p>			
⑦①② ①④	Power Supply		

Quick Keys	Parameter	Default	Range
	See <i>Manually Allocating & Configuring other Modules and Bus Devices</i> → <i>Power Supply Modules, page 59.</i>		
⑦①② ①⑤	Wireless Expander		
	See <i>Manually Allocating & Configuring other Modules and Bus Devices</i> → <i>Wireless Expanders, page 59.</i>		
⑦①② ①⑥	Proximity Key Reader		
	See <i>Manually Allocating & Configuring other Modules and Bus Devices</i> → <i>Proximity Key Readers, page 60.</i>		
⑦①② ①⑦	Voice Module		
	See <i>Manually Allocating & Configuring other Modules and Bus Devices</i> → <i>Voice Module, page 60.</i>		
⑦①② ①⑧	Sounder		
	See <i>Manually Allocating & Configuring other Modules and Bus Devices</i> → <i>Sounders (Sirens), page 61.</i>		
⑦①② ①⑨	BUS Zones		
	<p>Bus zones (bus detectors) can be wired to the main bus or to a Bus Zone Expander (BZE).</p> <p>See <i>Manually Allocating & Configuring other Modules and Bus Devices</i> → <i>Bus Zones (Bus Detectors), page 60.</i></p> <p>For additional details refer to the instructions supplied with each bus detector.</p> <p>Note</p> <p>The iWISE Bus detector and Elegant keypad have an additional 2-terminal input on board for connection to a relay detector [optional]. When selecting the iWISE Bus detector the following question will appear: "Link Bus Detector to zone xx?" Selecting Yes will assign the input as the consecutive zone of the selected iWISE Bus detector.</p>		
⑦①② ①⑩	GSM		
	See <i>Manually Allocating & Configuring other Modules and Bus Devices</i> → <i>GSM Modules, page 55.</i>		
⑦①② ①①	Bus Expander		
	See <i>Manually Allocating & Configuring other Modules and Bus Devices</i> → <i>Bus Zone Expander, page 62.</i>		
⑦①② ①②	LRT (Long Range)		

Quick Keys	Parameter	Default	Range
	Radio Transmitter)		
	See <i>Manually Allocating & Configuring other Modules and Bus Devices</i> → <i>Long-Range Radio Transmitter Module</i> , page 56.		
⑦①② 1 3	COB		
	See <i>Manually Allocating & Configuring other Modules and Bus Devices</i> → <i>Cellular On Bus (COB)</i> , page 56.		

Install → Bus Devices → Testing

Quick Keys	Parameter	Default	Range
⑦①③	Testing		
	The Testing menu enables performing a bus scan and a manual “Auto Setting” bus scan of the system.		
⑦①③ 1	Bus Test		
	<p>A Bus Test checks each installed bus device and communication module to ensure adequate connectivity quality.</p> <p>A result of 97% or less than may mean that there are bus connection problems.</p> <p>➤ To perform a Bus Test:</p> <ol style="list-style-type: none"> From the installer Programming menu, go to: 7 → 1 → 3 → 1 (Install → Bus Device → Testing → Bus Test); BUS TEST displays for a few seconds until the “BUS COM QUALITY” results display. Scroll to view the results for each bus device/module on the tested bus. If a result is not adequate, check physical connections and DIP switch positions, and then repeat the test. Results display as per this example GSM :001=100% <p>EXPLANATION:</p> <ul style="list-style-type: none"> GSM is the bus device/communication module description 001 is the bus device/communication module index number 100% is the result 		

Install → Bus Devices → Testing → Bus Scan (Auto Setting)

Quick Keys	Parameter	Default	Range
⑦①③ 2	Bus Scan (Auto Setting)		
	The Bus Scan is the same as the Auto Setting scan that is run at initial		

Quick Keys	Parameter	Default	Range
	<p>system start-up. The Bus Scan is typically used, for example, after manually allocating devices.</p> <p>➤ To perform a bus scan:</p> <ol style="list-style-type: none"> 1. Press OK (✓); BUS SCANNING displays during the scan, then the results display (the connected communication modules and bus devices that were found). 2. Press OK to enable the first communication module/bus device displayed, and keep pressing OK to progress through its parameter configuration screens (which you can configure now or later during installer programming). 3. Press OK again to advance to the next communication module/bus device found, and again enable/configure for all the remaining ones found. When BUS Device 1) Automatic displays again at the keypad and the panel beeps, it indicates you've finished going through all the recognized modules/devices. NOTE: Verify that all the system-connected modules and devices display in the results, and that they all have all been enabled. 4. Now you can perform a Bus Test to ensure good communication between the bus devices and the main panel (see <i>Performing a Bus Test</i>, page 54). <p>Describing Auto-Setting Results</p> <p>At the keypad, the results of a bus scan first show the connected communication modules. The next results displayed are for connected keypads, expansion/voice modules and bus detectors. Results display as per this example: (3:02:01) T=LCD</p> <p>EXPLANATION:</p> <p>NOTE: Dashes (“–”) appear instead of digits when a parameter is not relevant, for example, for communication modules as they are on-board the PCB, and not on a bus line.</p> <ul style="list-style-type: none"> • 3 is the bus line it is connected to • 02 is the expander ID • 01 is its sequential, installer-set physical ID number for bus devices Note that communication modules will always appear as 01. • T is the type, which, in this example is LCD 		

Install → Bus Devices → Bus Speed

Quick Keys	Parameter	Default	Range
⑦ ① ④	Bus Speed		
BUS 3: Select between Normal and Fast bus speed for picture transfer from the PIR Camera to Wireless Video Expander.			

⑦② Wireless Devices

The following parameters can be defined for wireless devices:

- **RX Calibration**
- **Allocation**
- **Delete**

Note

Allocation of wireless devices can be performed only if a wireless expander module has been defined in the system.

Install → Wireless Devices → RX Calibration

Quick Keys	Parameter	Default	Range
⑦②①	RX Calibration		
See <i>Measuring Background Noise Level and Defining the Threshold Limit</i> , page 70.			

Install → Wireless Devices → Allocation

Quick keys	Parameter	Default	Range
⑦②②	Allocation		
See <i>Step 4: Allocating Wireless Zones</i> , page 62.			
⑦②②①	By RF		
See <i>Allocating Wireless Devices via RF Transmission</i> , page 63.			
⑦②②②	By Code		
See <i>Allocating Wireless Devices via Code</i> , page 65.			

Install → Wireless Devices → Delete

Quick keys	Parameter	Default	Range
⑦②③	Delete		
Use this sub-menu to delete the allocation of a wireless device.			

⑧ Devices

Manually configure and modify installed system devices:

- Keypad
- Keyfob
- Sounder
- Proximity Key Reader
- Power Supply

⑧① Keypad

Devices → Keypad

Quick keys	Parameter	Default	Range
⑧①	Keypad		
NOTE: 🗡 = keypad number Select a keypad, press OK . The following can be defined for each keypad:			
⑧①🗡①	Label		
Enter a label identifying the keypad in the system.			
⑧①🗡②	Partition		
Enter a partition (01--32) for the keypad			
⑧①🗡③	Masking		
Specifies the partitions that are controlled by the specified keypad. Enter a number to clear it. Enter the number again to display it.			
⑧①🗡④	Controls		
Define these parameters: ① Emergency (Y/N) – to enable (Y) or disable (N) the keypad’s emergency keys per keypad. ② Multi view (Bus) YES: The keypad will display the status of all masked partitions. NO: The keypad will display only the status of its partition. ③ Exit beeps (for a 2-Way Slim keypad with bypass) YES: Exit / Entry beeps will sound. NO: Exit / Entry beeps will not sound. ④ Supervision (Y/N) – to enable (Y) or disable (N) supervision for a wireless keypad			
⑧①🗡⑤	Serial Number		
Displays the identifying 11-digit number of the allocated keypad			

Quick keys	Parameter	Default	Range
⑧①★⑥	Function Key (2-way)		
	<p>① Disable – Disables the keypad’s function key for Utility Output: ② Panic – Uses the keypad’s function key to send a panic alarm ③ MS Listen & Talk – Uses the keypad’s function key to establish 2-way “Listen & Talk” communication with the monitoring station.</p>		
⑧①★⑦	UO Key 1		
	Assign a utility output to be activated by a long press on function key 1		
⑧①★⑧	UO Key 2		
	Assign a utility output to be activated by a long press on function key 2		
⑧①★⑨	UO Key 3		
	Assign a utility output to be activated by a long press on function key 3		

⑧② Keyfob

Devices → Keyfob

Quick keys	Parameter	Default	Range
⑧②	Keyfob		
	<p>Options for the 1-Way Keyfob: The keyfob menu defines the operation of the wireless buttons keys. Each keyfob consists of 4 buttons, and each button can be programmed to a different mode of operation.</p> <ol style="list-style-type: none"> 1. The first step in the menu is to select a user. Each user has a single keyfob. When selected press OK (✓). 2. Select a button (1–4) and define the button operation according to the options below. 		
	<p>Note Each key has its own list of options. The list varies between the keys. The available modes of operation are:</p> <ul style="list-style-type: none"> ① None: Button disabled. ① Arm: The button is used for away (full) arming of the assigned partitions. ② Disarm: The button is used for disarming its assigned partitions. ③ Stay: The button is used for stay (home) arming of the assigned partitions. ④ Group: The button is used for Group arming. 		

Quick keys	Parameter	Default	Range
	<p>⑤ UO: The button is used to operate a single utility output</p> <p>⑥ Panic: The button is used to send a panic alarm.</p> <p>Note Stay (partial) arming or Away (full) arming can be defined as instant or delayed (Exit Delay).</p> <p>The available options for each button are:</p> <p>Button 1 (Ⓜ): None, Away, Stay, Group, UO</p> <p>Button 2 (Ⓜ): None, Disarm, UO</p> <p>Button 3: None, Away, Stay, Group, UO, Panic</p> <p>Button 4: None, Away, Stay, Group, UO</p>		
	<p>Options for 2-Way Keyfob</p> <p>The available programmable functions for the buttons:</p> <p>① Label</p> <p>⑤ Serial No</p> <p>⑥ Masking: Specifies the partitions that are controlled by the device.</p> <p>⑦ Controls → Panic Enable: Disable/enable panic alarm button</p> <p>⑧ PIN code (for arming in high-security mode)</p> <p>⑨ UO Key 1: Used to operate a single utility output</p> <p>⑩ UO Key 2: Used to operate a single utility output</p> <p>⑪ UO Key 3: Used to operate a single utility output</p>		

⑧③ Sounder

Define the following for an external siren that is connected to the LightSYS Plus as a bus accessory:

- **Parameter**
- **Bus Sounders**
- **2-Way WL Sounders**

Note

Access to this sub-menu requires that a sounder device is installed on your site.

Device → Sounder → Parameter

Quick Keys	Parameter	Default	Range
⑧③①	Parameters		
	Use this menu to define all parameters of the siren. Note that some parameters are only relevant for specific siren models.		

Quick Keys	Parameter	Default	Range
	Select a sounder and press OK .		

Device → Sounder → Parameter → Bus Sounders

Quick Keys	Parameter	Default	Range
⑧③①★①	Label		
	As assign the sounder a label (description)		
⑧③①★②	Masking		
	Use this menu to define parameters relating to masking		
⑧③①★③	Strobe		
	Use this menu to define parameters relating to the sounder strobe		
⑧③①★③①	Strobe Control	Follow Bell	
	Defines the strobe operation mode. ① ALWAYS OFF - The strobe is deactivated. ② FOLLOW BELL – The strobe is activated when the siren bell is triggered. ③ FOLLOW ALARM – The strobe is activated when an alarm occurs in the selected siren’s partitions.		
⑧③①★③②	Strobe Blink	40	
	Defines the number of times that the strobe will blink in a minute. ① 20 [Times/Min] ② 30 [Times/Min] ③ 40 [Times/Min] ④ 50 [Times/Min] ⑤ 60 [Times/Min]		
⑧③①★③③	Arm Squawk/Flash	01	01-20 (seconds)
	The time that the strobe will blink when the system is armed. Note If the siren’s squawk strobe is defined as NO (see the add/delete module, ⑦①②④⑧ <i>page 203</i>) this parameter will be ignored.		
⑧③①★④	Siren LED	Follow Arm	
	Defines the operation mode of the Status LED2. ① ALWAYS ON – The status LED2 is always on. ② ALWAYS OFF – The status LED2 is deactivated.		

Quick Keys	Parameter	Default	Range
	<p>3 FOLLOW ARM – The status LED2 is activated when any of the siren selected partition is armed (Away or Stay mode).</p> <p>4 FOLLOW ALARM - The status LED 2 is activated after any alarm condition.</p> <p>5 ALTERNATE (only for Lumin8) – The status LEDs will constantly alternate.</p> <p>6 FLASH (only for Lumin8) – The status LEDs will constantly flash.</p>		
ⓈⓃⓁⓈⓂ	Battery Load Test	Every 24 Hours	
	<p>Enables to set the time period that the LightSYS Plus will automatically generate a Load test on</p> <p>1 NEVER: The system will not set a battery load test</p> <p>2 EVERY 24 HOURS</p>		
ⓈⓃⓁⓈⓂ	Proximity Level Response	3	0–9 (seconds)
	<p>(Only for ProSound)</p> <p>Defines the time (seconds) for which a proximity violation must exist before the siren triggers an anti-approach alarm. The option 0 indicates that the proximity is deactivated.</p>		
ⓈⓃⓁⓈⓂ	Volume	9	0–9 (seconds)
	<p>Sets the bus siren's internal speaker Alarm volume. The volume ranges between 0 (silent) to 9 (max volume). After setting/changing the volume, sound will be emitted by the internal speaker to enable evaluation of the selected volume level.</p>		
ⓈⓃⓁⓈⓂ	Lamp		
	Use this menu to define parameters of the sounder external Lamp.		
ⓈⓃⓁⓈⓂ	Type		
	<p>Defines the way the external lamp will be operated.</p> <p>1 ALWAYS ON–The lamp is always on.</p> <p>2 ALWAYS OFF–The lamp is always off.</p> <p>3 SCHEDULER– The lamp operates according to the time defined under the Sounder Lamp menu (Quick Key: ⓈⓃⓁⓈⓂ).</p>		
ⓈⓃⓁⓈⓂ	Brightness	05	(01–10%)
	Used to set the brightness level of the external lamp.		
ⓈⓃⓁⓈⓂ	Power Source	SAB	SAB/SCB
	<p>(Only for Lumin8)</p> <p>Used to define the SAB or SCB power source mode of the LuMIN8:</p>		

Quick Keys	Parameter	Default	Range
	<ul style="list-style-type: none"> ❶ SAB—Power supply for the sounder will be drawn from the control panel. ❷ SCB—Power supply for the sounder will be drawn from the sounder’s rechargeable battery. 		
⓪ ③ ① ⚙ ① ①	Siren Current	Standard	Standard/Low
	<p>(Only for Lumin8) Set the sounder current mode.</p> <ul style="list-style-type: none"> ❶ LOW – The sounder output will be reduced to 106dB 150mA. ❷ STANDARD - The sounder output will be 112dB 350mA (assuming single piezo head). 		
⓪ ③ ① ⚙ ① ①	Alarm Sound		
	<p>(Only for Lumin8) Set the type of the alarm sound. Specify which of four alarm sounds is associated with this siren.</p>		
⓪ ③ ① ⚙ ① ②	Serial Number		
	<p>(Only for Lumin8) The identifying 11-digit number of the sounder (display only)</p>		
⓪ ③ ① ⚙ ① ③	Supervision		
	<p>(Only for Lumin8) Determines if this zone will be supervised by the system expander according to the time defined under the timer RX Supervision (see <i>RX Supervise, page 81</i>).</p>		

Device → Sounder → Parameter → 2-Way WL Sounders

Quick Keys	Parameter	Default	Range
⓪ ③ ① ⚙ ① ①	Label		
	You can define a label(name/description) for a sounder		
⓪ ③ ① ⚙ ① ②	Strobe		
	Use this menu to define parameters relating to the sounder strobe		
⓪ ③ ① ⚙ ① ② ①	Control	Follow Bell	
	<p>Defines the strobe operation mode:</p> <ul style="list-style-type: none"> ❶ ALWAYS OFF - The strobe is deactivated. ❷ FOLLOW BELL – The strobe is activated when the siren bell is triggered. 		

Quick Keys	Parameter	Default	Range
	3 FOLLOW ALARM – The strobe is activated when an alarm occurs in the selected siren’s partitions.		
⑧③①★①②②	Blink	40	
	Defines the number of times that the strobe will blink in a minute. 1 20 [Times/Min] 2 30 [Times/Min] 3 40 [Times/Min] 4 50 [Times/Min] 5 60 [Times/Min]		
⑧③①★①② 3	Arm Squawk	01	01 – 20 (seconds)
	The time that the strobe will blink when the system is armed. Note If the siren’s squawk strobe is defined as NO (see <i>Sounder, page 203</i>), then this parameter will be ignored.		
⑧③①★①③	Volume		
	Sets the WL siren's internal speaker Alarm volume - range is between 0 (silent) to 9 (maximum). After setting, sound will be emitted by the internal speaker to enable evaluation of the selected volume level.		
⑧③①★①③ 1	Alarm	9	(1–9)
	General alarm volume		
⑧③①★①③ 2	Squawk	9	(1–9)
	Squawk sound alarm		
⑧③①★①③ 3	Exit Entry	9	(1–9)
	Notification of system status in exit or entry delay.		
⑧③①★ 04	Serial No.		
	The identifying 11-digit number of the sounder (display only)		
⑧③①★ 05	Supervision		
	Determines if this zone will be supervised by the system expander according to the time defined under the timer RX Supervise, page 81).		
⑧③②	Lamp Times		
	Specify here the sounder lamp illumination duration. 1 Lamp Start - Specify here the start time for the sounder lamp to be activated.		

Quick Keys	Parameter	Default	Range
	② Lamp Stop - Specify here the stop time for the sounder lamp to be deactivated.		

⑧④ Proximity Key Reader

Define or modify parameters of a Proximity Key Reader that can be connected to the LightSYS Plus as a bus accessory. Up to 64 PKR's can be connected to the system.

Note

Access to this sub-menu requires that a Proximity Key reader device is installed.

Devices → Proximity Key Reader

Quick keys	Parameter	Default	Range
⑧④⚙️①	Masking		
	<p>To specify the partitions that are/are not controlled by the specified PKR:</p> <ol style="list-style-type: none"> 1) Press OK (✓), scroll to select the PKR index number, and then press OK. 2) Scroll to MASKING, and then press OK. 3) Scroll through each block of partitions (32 partitions maximum — all enabled by default), and designate the partitions to mask (to not allow operation via the keypad) by entering a partition number to delete it (it will not display), or enter the number again to select it (it will display). 4) When finished, press OK. 		
⑧④⚙️②	Control		
	<ol style="list-style-type: none"> 1). Use this menu to define controls of the PKR. Scroll the list and toggle Y/N for each option (see <i>page 203</i>). <ul style="list-style-type: none"> ① INSTANT ARM? ② SHOW READY? ③ SHOW ARM? ④ SHOW STAY? ⑤ SHOW BYPASS? 2). When done press OK to save your settings. 		

⑧⑤ Power Supply

Define or modify parameters of a power supply expansion module connected to the LightSYS Plus as a bus accessory. Up to 32 power supply expansion modules

(1.5A or 3A) can be connected to the system (maximum 8 per bus line).

Devices → Power Supply

Quick Keys	Parameter	Default	Range
⑧ ⑤ ⌂ ①	Masking		
	<p>To designate which partition will or will not be operated at the keypad:</p> <ol style="list-style-type: none"> 1) Press OK (✓), scroll to select the power supply index number, and then press OK. 2) Scroll to MASKING, and then press OK. 3) Scroll through each block of partitions (32 partitions maximum – all enabled by default), and designate the partitions to mask (to not allow operation via the keypad) by entering a partition number to delete it (it will not display), or enter the number again to select it (it will display). 4) When finished, press OK. 		
⑧ ⑤ ⌂ ②	Control		
	<p>To enable/disable the bell/loudspeaker for the power supply module:</p> <ol style="list-style-type: none"> 1) Press OK, scroll to select the power supply index number, and then press OK. 2) Scroll to CONTROL, and then press OK. 3) Toggle between Y (yes) or N (no) for enabling or disabling the power bell/loudspeaker, and then press OK. 		

⑩ Exit

When exiting installer Programming menu, go to **0) Exit** and then press **OK** (✓). Note that if exiting after programming in the installer Programming menu the very first time (at initial system configuration), perform the following procedure:

Exiting Installer Programming Menu

Exiting Installer Programming Menu after Initial System Programming

IMPORTANT: After you have finished programming all relevant parameters in the installer Programming menu **the first time – at the time of initial system setup**, you must then perform the following procedure to exit the installer Programming mode. Afterwards you can then program additional parameters as needed from the same menu, or from other installer menus.

➤ To exit installer Programming menu after initial system programming:

WARNING: In the main panel box/enclosure do not touch any AC electrical wiring to/from the mains fuse terminals nor the mains fuse terminals, as coming into contact with 230 VAC can result in electric shock and death.

1. Close the main panel box/enclosure in order to prevent a front tamper alarm.
2. At the keypad, press **Exit** () repeatedly to return to the start of the current menu.
3. Press **0** to exit, toggle to **Y** to save all your programming settings, and then press **OK** (✓); TAMPER TESTING displays as the system checks for tamper trouble conditions.
4. If an alarm sounds and you want to quit with a current tamper trouble condition, press **Exit**, then toggle to **Y** (yes), and then press **OK**.

NOTE: If you select **N** (no), you will not be able to exit installer Programming mode until the tamper trouble condition has been restored to normal.

Restoring Manufacturer's Programming Defaults

You can revert to manufacture defaults for all system parameters.

➤ **To restore the main panel to the manufacturer's defaults:**

1. From the installer Programming menu, select **1→ 5→ 2 (System→Setting→ Default Panel)**.
1. To restore the system labels to the manufacturer defaults (delete all labels), toggle to **Y** (yes) and then press **OK** (✓) to confirm.
2. To revert to the default panel and keep existing labels, toggle to **N**, and then press **OK**.
NOTE: It may take a minute or two to process, but wait until **SETTINGS: 2) DEFAULT PANEL** displays.
3. To save your settings exit the Programming mode.

Defining Parameters – Additional Installer Menus

You can program additional system parameters in installer menus (other than the Programming menu):

Activities Menu

Activities parameters
<p>Keypad Sound</p> <p>Chime</p> <p>Keypad Chime—Use the scroll buttons to turn the keypad's internal sounder ON or OFF for any function utilizing the chime.</p> <p>Partition Chime—Use the scroll buttons to turn internal sounders ON or OFF for all keypads in the partition (for all functions utilizing the chime).</p> <p>Buzzer ON/OFF—Use the scroll buttons to turn the keypad's internal buzzer ON or OFF during both Entry and Exit Delay time periods, and during all fire and intrusion alarms.</p>
<p>Advanced</p> <p>Service Mode—Press OK to activate / deactivate the service mode, which silences alarms in order to enable battery replacement for detectors and accessories. For setting Service Mode parameters, see <i>Service Mode on page 181</i>.</p> <p>MS Test — Press OK to initiate a test message to the monitoring station according to IMQ and EN50131 requirements.</p> <p>Wi-Fi Scan-The Control panel scans for Wi-Fi networks and shortly after available networks appear in a list (the connected network is marked and appears first in the list). The rest of the list is sorted from high RSSI to low, with a max. 20 networks. Scroll to your Router's Wi-Fi network, select the desired network and then press [enter]. Enter the Password, if required, and press [enter]. If connection is successful, a successful message is displayed. If there is a connection failure, an error message is displayed.</p> <p>Note: Your Router's Wi-Fi must be activated for the Control Panel to recognize and communicate with the Router.</p> <p>Wi-Fi WPS Button-Press the WPS button on the router to establish a connection. A "Successfully Connected" to network message will appear within 2 min.</p>

Follow Me Menu

Follow Me parameters
Define – Press OK , and then scroll to a FM destination number (up to 64) to define
For the selected FM destination number, enter the Follow Me destination information, according to its type (voice message, SMS or E-mail), and then press OK . For more information, see <i>Follow Me, page 189</i> .
Label – For the selected FM destination number, scroll to enter (over the existing or default label) an identifying description, and then press OK .
Terminate Follow Me – A Follow Me destination can be terminated (deleted).
Test FM – For testing Follow Me reporting

View Menu

View parameters
Trouble – Scroll to view system troubles. Troubles may also be indicated by the power icon () flashing on specific keypad models.
Alarm Memory – Displays the 5 most recent alarm conditions stored in the system
Partition Status – Scroll to view partition status and NR (not ready) zones in the system.
Note
<ul style="list-style-type: none"> • Pressing on the scroll keys from the normal operation mode displays the status of the partition to which the keypad is assigned • For each user code, displays the status of all respective partitions assigned to that user
Zone Status – Scroll to view all system zones and their current status.
Service Information – Scroll to the following options:
Installer – View any previously entered service / installer information
System Version – View the version number and date of the installed system software
Serial Number – View the 11-digit serial number of the main panel
Panel ID – View the 15-digit panel ID number
Cloud Status - Scroll to view the Cloud Status
Wi-Fi Status - Scroll to view the Wi-Fi Status

Clock Menu

Clock parameters

Time & Date – To set the system time and date, scroll to each space and enter/re-enter the time and date definitions (required for all Scheduler programming – see below).

Scheduler

NOTE: For complete Scheduler and Vacation procedures, see the *LightSYS Plus User Manual*.

You can configure the following automated system operations according to schedules (and other criteria) that you define:

- Arming/disarming the system **one-time** only within the next 24 hours
- Up to 64 **re-occurring weekly schedules** for arming/disarming the system and/or activating/deactivating up to 4 UOs (utility outputs)
- Up to 99 **vacation schedules** for UO activation and system arming

One-Time: Define a one-time automatic arm/disarm of the system at a specific time within the next 24 hours.

Weekly Schedules: Define up to 64 weekly schedules for automatic arming/disarming and automatic activation/deactivation of utility outputs. Each schedule can be defined with up to 2 time intervals (2 separate start & stop times) per day. For automatic arming/disarming, you have the option to set a "user limitation" safeguard that prevents users that you define from disarming the system during time intervals that you specify.

Inactivity Timer (for Arm/Disarm option): If there is no detection from any of the zones in partitions with an automatic schedule (that has the Arm/Disarm option defined by the Grand Master with the Inactivity Timer set to ON), then those partitions will be automatically armed according to the Inactivity Timer parameter definition (see *Inactivity Timer on page 83*).



Vacation – To set up to 99 vacation schedules for automatic arming & UO activation (with respective dates/ times as well as partitions for arming)

Event Log Menu

Event Log parameters

View of up to 2000 system events. Each event displays with the date and time. Scroll to an event number, and then press **OK** to view its details.

Notes

- The events memory cannot be erased
- To skip to blocks of 100 events backward or forward, use   respectively

Maintenance Menu

Maintenance parameters

Walk Test – Test and evaluate the operation of selected zones in the system. A walk test is set for up to 60 minutes. During the last 5 minutes, the keypad used to activate the test will indicate that the test is about to end.

- **Full Walk Test** (areas activated) – Displays the activated zones and type of detector
- **Quick Walk Test** (areas not activated) – Displays the non-activated zones.

Keypad Test – Activates the keypads and momentarily tests the keypad indicators.

Siren Test – Activates the alarm sound from each bus sounder, from the Bell terminals on the main board and activates utility outputs defined as Bell Trigger (③② ②②).

Strobe Test – Activates all strobes in connected bus sounders and activates utility output defined as Follow Strobe (③② ②③).

Wireless Test – For all allocated keyfobs, wireless zones, and wireless keypads:

Comm.Test – Displays the last measurement taken at the last transmission (last detection or last supervision signal) of the selected device. To receive the updated signal strength, activate the detector prior to performing the communication test. For successful communication, the strength of the signal should be higher than the noise threshold level as measured during calibration of the panel (see *Performing a Wireless Comm. Test for Measuring Signal Strength*, page 71).

Battery Test – Displays the last battery test results of the selected device taken at the last transmission. A confirmation message displays if the test was successful. In addition, you can activate the device.

Diagnostics

You can activate the following tests for system diagnosis:

- **Main Battery Test** – Tests the level of the main panel's backup battery. Press **OK** to start the test; the result displays.
- **Zone Resistance** – Tests the resistance and voltage level of the wired zones in the system. Press **OK** and then scroll to the zone to be tested. Press **OK** to toggle between viewing the resistance and voltage for the selected zone. Scroll to other zones to test as needed.

Maintenance parameters

- **Zone Expander** – Tests installed zone expanders. Press **OK**, scroll to the zone expander to test, and then press **OK** again. Now scroll to either view the results for **DIAGNOSTICS** or **VERSION**, and press **OK**; the corresponding information displays
- **Power supply** – Tests the installed power supplied expanders and displays the relevant information for each power supply.
- **Siren** – Tests installed bus sirens and displays information regarding each siren (depending on siren type). Press **OK**, scroll to the siren to test, and then press **OK** again. Now scroll to either view the results for **DIAGNOSTICS** or **VERSION**, and press **OK**; the corresponding information displays.
- **GSM module** – Tests the following for the installed GSM module:
 - ❖ **Signal (RSSI)** – Displays the signal level measured by the GSM module (0 = no signal, 5 = very high signal)
 - ❖ **Version** – Displays information regarding the GSM module version
 - ❖ **IMEI** – Displays the IMEI number of the GSM module. This number is used for identification of the LightSYS Plus at the RISCO IP Receiver when using GSM or GPRS/3G/4G communication
- **IP** – Performs a diagnostic test for the following parameters of the plug in IP:
 - ❖ **IP Address** – View the system's IP address
 - ❖ **MAC Address** – View the MAC address of the IP. This number is used for identification of the system at the RISCO IP Receiver when using the IP communication module.
 - ❖ **WIFI MAC Address** – View the MAC address of the IP. This number is used for identification of the LightSYS Plus at the RISCO IP Receiver when using Wi-Fi Communication.
- **WME Version** – Displays the selected wireless expansion module's software version/date
- **Panel Version** – Displays the main panel (system) software version/date
- **Voice Version** – Displays the voice module's software version/date
- **Keypad Version** – Displays the selected keypad's software version/date
- **LRT** – Displays the LRT module software version and its active protocol
- **W2W Zone Version** – Displays the wireless 2-Way zone version
- **W2W KF Version** – Displays the wireless 2-Way keyfob version
- **COB** – Displays the Cellular-on-Bus Module version
- **BZE Version** – Displays the Bus Zone Expander version

Macro Menu

Macro parameters

Test a selected macro, if it has been pre-programmed. Scroll to select the respective macro (A–D), and then press **OK**. For more information on programming macros, see the *LightSYS Plus User Manual*.

Stand Alone Keyfob Menu

Stand Alone Keyfob parameters

Standalone keyfobs are used for gate control (with a dedicated wireless expander module).

Scroll to select the wireless expander module used for the standalone keyfobs/gate control, and then press **OK**. For the respective keyfobs supported, select from the following parameters to configure. For more information on standalone keyfobs, see the *LightSYS Plus User Manual*.

- **New Keyfob** – To allocate a new keyfob
- **Delete Keyfob** – To delete the allocation of a keyfob
- **Delete All** – To delete all keyfob allocations (the keyfobs using the dedicated wireless expansion module for gate control only)
- **UO Buttons** – To change the keyfob buttons that control utility outputs

Testing the System

It is important to fully test the system. Here are typical, recommended system tests that should be performed at system installation, and subsequently as needed:

- ✓ **Bus Test:** To test bus communication quality. See *Performing a Bus Test*, page 54.
- ✓ **Background noise-level threshold & calibration for wireless devices:**
See *Measuring Background Noise Level and Defining the Threshold Limit*, page 70.
- ✓ **Wireless Communication Test:** For testing the signal strength of wireless devices. See *Performing a Wireless Comm. Test for Measuring Signal Strength*, page 71.
- ✓ **Walk Test (for zones):** Arm the system, and then enter the protected area in order to trigger alarm events at each detector to ensure operability. See the installer **Maintenance menu** → **Walk test**, page 224.
- ✓ **Monitoring Station Test:** See **View Menu** → **Advanced** → **MS Test**, page 222.
- ✓ **GSM signal strength (RSSI):** View the signal strength result measured by the GSM module (from 0–5). Go to: **installer Maintenance menu** → **Diagnostics** → **GSM** → **Module**, page 224.
- ✓ **Additional tests at the installer Maintenance menu:** For keypads, sirens, strobes, wireless, and diagnostics (including main battery test, and zone resistance test). See from page 224.
- ✓ **Follow-Me Test:** After programming FM destination(s), go to: installer **Follow Me Menu** → **Test**. Trigger an alarm activation (for example, as done during a Walk Test), and see if the FM notification is received at the FM destination(s). See *Follow Me Menu*, page 221.

Installer Responsibilities for Assisting the Client

Here are some typical, recommended areas for you to assist the client, upon handing over system after installation:

- ✓ Advise client to change the default Grand Master code to one that is confidential.
- ✓ For RISCO Cloud-enabled communication, instruct users with Smartphones to download the iRISCO app from the Apple App store or Android Play Store, and ensure that a connection between the app and the system is established.
- ✓ Instruct how to define user codes, proximity tags, and Follow-Me destinations.
- ✓ Instruct how to do the following from keypads and keyfobs:
 - Full arm, partial arm, disarm
 - Send a duress disarm (silent alarm) to the monitoring station
 - Activate a panic alarm
 - Check system status
 - Use SMS for remote operation
 - Operate Listen-In & Speak Unit

Appendix A: Technical Specification

Main Panel	Technical Information
Input Power:	AC/DC Adaptor 100-240 V, 50/60Hz, 14.4V (+/-5%) —2.5A/4.5A PS
Current Consumption:	110 mA, typical, 180 mA, maximum
Rechargeable Standby Battery:	12 V, 21Ah (Amp-hours) for RP512B and RP432BP3 housing 12 V, 7Ah (Amp-hours) for RP432BP housing
Output Voltage Range	11V –13.8V (ripple 200 mV)
Power Output	<ol style="list-style-type: none"> 1. Maximum current draw from each bus (“AUX RED” terminals is 500 mA 2. Maximum current draw from Bell/LS terminal is 500 mA 3. Maximum current draw from the AUX terminal 1A
Programmable outputs:	UO1: Dry contact relay (24V, 1 Amp) UO2: 500 mA transistor (Open Collector) UO3 – UO4: 100 mA, opto relay
Main box/enclosure dimensions	RP432BP 288 x 256 x 103.5 mm RP432BP3 403 x 321.5 x 115.5 mm RP512B 403 x 321.5 x 115.5 mm
Operating temperature	-10°C to 55°C (14°F to 131°F)
Average Relative Humidity	75%
Weight	RP432BP 1.396Kg (3.396 including battery) RP432BP3 2.38 Kg (7.53Kg including battery) RP512B 1.5 Kg (6.65Kg including battery)
Overvoltage Protection	18V
Power Output Fault	8.3V
Keypads, Expansion Modules, Communication Modules	Technical Information
RisControl IPS Touchscreen Keypad (RP432KPT)	13.8V ±10%, 170 mA, 5W max.
Elegant Keypad (RPKEL)	12 V +/-15%, 100 mA maximum
Elegant Keypad – Proximity (RPKELP)	12 V +/-15%, 150 mA maximum
LCD Keypad (RP432KP)	13.8 V +/-10%, 48 mA typical, 52 mA maximum

Proximity LCD Keypad (RP432KPP)	13.8 V +/-10%, 62 mA typical, 130 mA maximum
Panda wired LCD Keypad, Proximity (RP432KPP2)	13.8 V DC +/-10%; 130 mA typical/180 mA max.
Panda wired LCD Keypad (RP432KP02)	13.8 V DC +/-10%; 130 mA typical/180 mA max.
Single Zone Expander (RP128EZ1)	13.8 V DC +/-10%; 20 mA
8 Zone Expansion Module (RP432EZ8)	20 mA, typical, 29mA maximum
Bus Zone Expander (RP128EZB)	20 mA
Wireless Video Expander (RP432EWV)	40 mA typical; 65 mA maximum
Wireless Security Module (RP432EWS)	40 mA typical; 65 mA maximum
Wireless Expansion Module (RP432EW8, RP432EW4)	13.8 V DC +/-10%; 40 mA typical, 65 mA maximum
4 x 3A relay Output Expansion Module (ProSYS E04)	13.8VDC +/-10%; 25 mA typical / 160 mA maximum 4 Form C (SPDT) Relays.; 5 A / 24V DC
[Italy] Prox. Key Reader (ProSYS PKR3)	13.8 V DC +/-10%; 70 mA, typical, 180 mA maximum
Digital Voice Module (RP432EV)	13.8 V DC +/-10%; 30 mA typical, 70 mA maximum
Listen & Speak Unit (RP128EVM)	7 V DC, 10mA standby, 60mA typical, 130 mA maximum
Plug-in multi-socket 2G GSM Module (RP512G2/RP512G2T)	30 mA standby, 300 mA communicating
Plug-in multi-socket 3G GSM Module (RP512G3)	30 mA standby, 300 mA communicating
Plug-in multi-socket 4G GSM Module in plastic box (RP512G4/RP512G4T)	30 mA standby, 300 mA communicating
3A Supervised Switching PS Expansion modules (ProSYS 3APS, ProSYS 3APSB)	Input: 16.5 V AC @ 50 VA (via 230 V AC—16.5 V AC transformer) Aux output: 3 A @ 13 VDC; Bell/LS (external) sounder output: 1.7 A @ 13 V DC

Appendix B: Wiring

The proper use of wire and cable is necessary for the successful installation and operation of the LightSYS Plus system. It is important to select wire of the correct attributes to minimize power loss and ensure reliable system operation. Take into account both the installation's current requirements (for this you can utilize the HandyApp calculator feature) and the wiring distances involved. The following tables provide useful information:

Resistance per AWG Size and Distance

AWG Gauge Size	Wire Diameter		Resistance: Meters		Resistance: Feet	
	Millimeters	Inches	Ω Per Meter	Ω Per 100 Meters	Ω Per Foot	Ω Per 1000 Feet
24	0.50	0.020	0.085	8.5	0.026	26.0
22	0.64	0.025	0.052	5.2	0.016	16.0
20	0.80	0.031	0.032	3.2	0.010	10.0
19	0.90	0.035	0.026	2.6	0.008	8.0
18	1.00	0.040	0.020	2.0	0.006	6.0
16	1.27	0.050	0.013	1.3	0.004	4.0
14	1.63	0.064	0.008	0.82	0.0025	2.5

Wiring Distance between Panel and Plug-In Transformer

One-Way Wire Distance Between LightSYS Plus main panel and Plug-In Transformer		AWG (American Wire Gauge) For best results use the indicated wire size or larger (numerically lower) size				
In Meters	In Feet	22	20	18	16	14
Up to 5	Up to 15	4				
5 - 8	15 - 25		4			
8 - 12	25 - 40			4		
12 - 20	40 - 60				4	
20 - 30	60 - 100					4

Maximum Combined Length of all Expansion Bus Wiring

Wire Gauge		Max Combined Length of ALL Expansion Bus Wiring	
24 AWG	7/02mm	150 meters	492 feet
22 AWG	16/02mm	200 meters	656 feet
20 AWG	24/02mm	333 meters	1092 feet
19 AWG	28/02mm	400 meters	1312 feet

Notes

- For maximum system stability, it is best not to exceed a total of 300 meters (1000 feet) of wire when wiring the bus.
- For a distance of more than 300 meters, refer to RISCO Group Technical Support services for detailed information.

Total Auxiliary Power

Total Auxiliary Power (Max Current Draw per Branch)	Desired Wire Gauge in Particular Branch									
	32/02 mm 18 AWG		28/02 mm 19 AWG		24/02 mm 20 AWG		16/02 mm 22 AWG		7/02 mm 24 AWG	
	Max Run		Max Run		Max Run		Max Run		Max Run	
	Meters	Feet	Meters	Feet	Meters	Feet	Meters	Feet	Meters	Feet
20mA	1195	3920	945	3100	750	2460	472	1550	296	970
30mA	793	2600	628	2060	500	1640	314	1030	197	646
40mA	597	1960	472	1550	375	1230	236	775	148	485
50mA	478	1568	378	1240	300	984	189	620	118	388
60mA	296	1300	314	1030	250	820	157	515	98	323
70mA	341	1120	270	886	214	703	135	443	84	277
80mA	299	980	237	775	187	615	118	388	74	243
90mA	264	867	209	687	166	547	105	343	66	215
100mA	239	784	189	620	123	492	94	310	59	194

Note

The wire lengths indicated represent the one-way distance between the source of power and the last detector in the branch.

Maximum External Sounder Current

Max External Sounder Current (Max current draw per branch)	Desired Wire Gauge in Particular Branch							
	32/02 mm		28/02 mm		24/02 mm		16/02 mm	
	Max Run		Max Run		Max Run		Max Run	
	Meters	Feet	Meters	Feet	Meters	Feet	Meters	Feet
100mA	238	780	191	625	151	495	94	310
200mA	229	390	95	313	76	248	47	155
300mA	79	260	63	208	50	165	31	103
400mA	59	195	48	157	38	124	24	78
500mA	48	156	38	125	30	99	19	62
650mA	37	120	29	96	23	76	15	48

Note

The wire lengths indicated represent the one-way distance between the LightSYS Plus and the external sounder in the branch.



Appendix C: Installer Event Log Messages

Event Message	Description
AC Low PS=y	Loss of AC power from power supply ID=y
AC RST PS=y	AC power restore on power supply ID=y
Activate UO=xx	UO XX activation
Actv UO=xx KF=zz	UO XX is activated from remote control ZZ
AL.ReinstateP=Y	Alarm reinstatement on partition Y
Alarm Z=xx	Alarm in zone no. XX
Alrm Cancel P=y	Alarm is cancelled in partition ID=Y
AMPRX DTCT Z=xx	Anti mask proximity detection on bus zone XX
AMPRX RSTR Z=xx	Anti mask proximity detection restore on bus zone XX
ARM A:P=y C=zz	Group A on partition Y is armed by user ZZ
ARM A:P=y KF=zz	Group A on partition Y is set by wireless keyfob ZZ
ARM B:P=y C=zz	Group B on partition Y is armed by user ZZ
ARM B:P=y KF=zz	Group B on partition Y is set by wireless keyfob ZZ
ARM C:P=y C=zz	Group C on partition Y is armed by user ZZ
ARM C:P=y KF=zz	Group C on partition Y is set by wireless keyfob ZZ
ARM D:P=y C=zz	Group D on partition Y is armed by user ZZ
ARM D:P=y KF=zz	Group D on partition Y is set by wireless keyfob ZZ
ARM FAIL P=y	Fail to Arm Partition X by Guard due to not ready zones
ARM:P=y C=zz	Partition Y armed by user ZZ
ARM:P=y KF=zz	Partition Y armed by wireless keyfob ZZ
Aut tst fail	Failure of zone self-test
Auto test OK	Automatic zone self-test OK
Aux RS PS=y	Restore of Aux power on power supply ID=Y
Aux RS ZE=y	Restore of S. Aux power on zone expander Y
Aux TRBL RS S=y	Auxiliary trouble restore on the siren ID=Y
Aux TRBL SIR.=y	Auxiliary trouble on the siren ID=Y
Bat Load RS S=y	Battery load trouble restore from siren ID=Y
Bat Load SIR.=y	Battery load trouble from siren ID=Y
Bat Rst PS=y	Low battery trouble restore from power supply ID=Y
BELL RS PS=y	Bell trouble restore in power supply ID=Y
Bell tamper	Bell tamper alarm
Bell tmp rs	Bell tamper alarm restore
Box tamper	Box tamper alarm from main unit
Box tmp rs	Box tamper alarm restore
Bypass Box+Bell	Box + Bell tamper is bypassed

Event Message	Description
Byp Trbl C=xx	System troubles were bypassed by user XX
Bypass Zn=xx	Zone no. XX is bypassed
Charge Curr S=y	Battery charging trouble in siren ID=Y
Chng code=xx	Changing user code XX
Change FM=yy	Changing Follow-Me number YY
Charge Current RS S=y	Battery charging trouble restore in siren ID=Y
Clk not set	Time is not set
Clk set C=xx	Time defined by user no. XX
Cloud Comm.Trbl	Communication problems with the Cloud channel
Cloud Connected	Cloud communication channel is functioning
Cloud Disconnect	Cloud communication channel is not functioning
Cloud Login Err	Login problems with the Cloud channel
CO Alarm Z=xx	CO alert from zone XX defined as a CO detector
CO Rst. Z=xx	CO alert restored from zone XX defined as a CO detector
Comm OK IP	Communication OK between the LightSYS Plus and IP
Comm OK KP=y	Bus communication restore with keypad ID=Y
Comm OK KR=y	Bus communication OK with Proximity Key Reader Y
Comm OK VOICE	Bus communication OK with Advanced Voice module
Comm OK WME=y	Bus communication OK with wireless module expander ID=Y
Comm OK BZE=y	Bus communication OK with Bus Zone Expander ID=Y
Comm OK PS=y	Bus communication restore with power supply expander ID=Y
Comm OK Siren=y	Communication OK between the LightSYS Plus and Siren Y
Comm OK UO=y	Bus communication restore with UO expander ID=Y
Comm OK Z=xx	Bus communication OK with bus zone XX
Comm OK ZE=y	Bus communication restore with zone expander ID=Y
Comm. OK GSM	Communication OK between the LightSYS Plus and GSM
Comm.OK LRT	Communication OK between the LightSYS Plus and the long range transmitter
Conf. Z=xx	Confirmed alarm occurred from zone XX
Conf. alarm P=y	Confirmed alarm occurred in partition Y
Conf.holdup P=y	Confirmed holdup occurred in partition Y
Confirm rs Z=xx	Restore zone confirmed alarm
CP reset	The control panel has reset
Dat set C=xx	Date defined by user no. XX
Day A:P=y	Daily arm on partition Y
Day Arm:p=y	Daily Arm on Partition Y
Day b:p=y	Arm by scheduler of group B on partition Y

Event Message	Description
Day c:p=y	Arm by scheduler of group C on partition Y
Day d:p=y	Arm by scheduler of group D on partition Y
Day dis:P=y	Daily disarm on partition Y
Day hom:P=y	Daily Stay or Group arming in partition Y
DC Restore Z=XX	DC trouble restore in Bus zone XX
DC Trouble Z=XX	DC trouble in Bus zone XX
Dis:P=y C=zz	Partition Y disarmed by user ZZ
Dis: P=y KF=zz	Partition Y disarmed by remote control ZZ
Duress P=y C=xx	Partition Y duress alarm from user no. XX
DUST RST Z=xx	Dust trouble restore from WatchOUT DT Bus zone XXX
DUST Z=xx	Dust trouble from WatchOUT DT Bus zone XXX
EE AC.UPLOAD	Load new parameters from PTM accessory
Enter progrm	Entering installer programming from keypad or configuration software
Exit program	Exiting installer programming from keypad or configuration software
F.Tr OK Z=xx	Trouble restore in fire zone no. XX
F.Trbl Z=xx	Trouble in fire zone no. XX
Fire Zone=xx	Fire alarm in zone no. XX
False code kp=y	False code due to 3 incorrect keypad attempts
False code kr=y	False code due to 3 incorrect Access Control attempts
False rest.kp=y	False code is restored for keypad
False rest.kr=y	False code is restored for key reader
Fault z=xx	Trouble in zone XX
Fire z=xx	Fire alarm in zone XX
Fire kp=y	Fire alarm from keypad (ID=XX) (keys 3 & 4)
Foil ok Z=xx	Restore in foil (Day) zone no. XX
Foil Z=xx	Trouble in foil (Day) zone no. XX
Forced P=y	Partition Y is force armed
Found Z=xx	Wireless zone found, zone no. XX
Func=xx C=yy	Quick key function XX by user YY
Gas Alarm Zn=xx	Gas (natural gas) alert from zone XX defined as a gas detector
Gas Rst. Z=xx	Gas (natural gas) alert restored from zone XX defined as a gas detector
GSM:GPRS PW ERR	Authentication password is incorrect
GSM:GPRS PW OK	Authentication password is correct
GSM:IP OK	IP connection OK
GSM:IP Trouble	IP address is incorrect

Event Message	Description
GSM:Mdl comm.OK	Communication between the GSM/GPRS/3G/4G Module and the LightSYS Plus is OK
GSM: Module comm.	Internal GSM/GPRS/3G/4G bus module trouble
GSM:MS OK	GPRS/3G/4G communication to the MS is OK
GSM:MS trouble	GPRS/3G/4G communication failure to the MS
GSM:NET avai.	GSM network is not available
GSM:NET avai.OK	GSM Network is available
GSM:NET qual.OK	GSM Network quality is acceptable
GSM:NET quality	The GSM RSSI level is low
GSM:PIN cod.err	PIN code entered is incorrect
GSM:PIN code OK	PIN code is correct
GSM:PUK Cod err	PUK code required
GSM:PUK Code OK	PUK Code entered is correct
GSM:SIM OK	SIM Card in place
GSM:SIM trouble	SIM card missing or not properly sited
H.Temp rst Z=xx	High temperature alert restored from zone XX defined as a temperature detector
High Temp. Z=xx	High temperature alert from zone XX defined as a temperature detector
HOM:P=y C=zz	Partition Y is armed in Stay mode by user ZZ
HOME:P=y KF=zz	Partition Y is home armed using keyfob ZZ
HU.ReinstateP=y	Hold-Up Reinstatement in partition y
IP:DHCP error	Failed to acquire an IP address from the DHCP server
IP:DHCP OK	Succeeded to acquire an IP address from the DHCP server
IP: downld err	IP generated a download error
IP: download OK	IP download was OK
IP: evnt log ER	IP generated an event log error
IP: evnt log OK	IP event log generated no error
IP: hardware OK	IP hardware is OK
IP: hardware error	IP generated a hardware error
IP: mail error	IP generated a mail error
IP: mail OK	IP mail is OK
IP:MS=y error	IP Monitoring station ID=Y generated an error
IP:MS=y OK	IP Monitoring station ID=Y was OK
IP: Network err	Failed to connect to IP network
IP: Network OK	Successful connection to IP network
IP:NTP error	Failed to acquire time data from the time server
IP:NTP ok	Succeeded to acquire time data from the time server

Event Message	Description
IP: upgrade err	The IP upgrade generated an error
IP: upgrade OK	The IP upgrade was OK
IR restore Z=xx	Trouble restore in the IR channel of bus zone XX
IR trouble Z=xx	Trouble in the IR channel of bus zone XXX
JAMM. WME=y	Jamming in wireless module expander ID=Y
KeyBox Open Zxx	Zone XX of type key box is open
KeyBox Rst Z=xx	Zone XX of type key box is restored
KP=\$ Lost	Keypad is lost
KP=\$ Lost Rs	Lost keypad has been restored
KP=\$ LOW BAT.	Low Battery trouble for the keypad
KSW A: Z=xx P=Y	Group A in partition Y is armed by keyswitch zone XX
KSW ARM:Z=xxP=Y	Partition Y is armed by keyswitch zone XX
KSW B: Z=xx P=Y	Group B in partition Y is armed by keyswitch zone XX
KSW C: Z=xx P=Y	Group C in partition Y is armed by keyswitch zone XX
KSW D: Z=xx P=Y	Group D in partition Y is armed by keyswitch zone XX
KSW DIS:Z=xxP=Y	Partition Y is disarmed by keyswitch zone XX
LB rstr KF=yy	Low battery trouble restore from wireless remote control YY
L.Temp rst Z=xx	Low temperature alert restored from zone XX defined as a temperature detector
LB RSTR Z=xx	Low battery restore from wireless zone XX
Lost Z=xx	Wireless zone lost, zone no. XX
Low Bat KF=xx	Low battery trouble from wireless remote control ID=XX
Low Bat PS=y	Low battery trouble from power supply ID=Y
Low Bat RS Z=xx	Low battery trouble restored from wireless zone no. XX
Low Bat Siren=y	Low battery trouble from siren ID=Y
Low bat Z=xx	Low battery trouble from wireless zone no. XX
Low Temp. Z=xx	Low temperature alert from zone XX defined as a temperature detector
LRT:ACCOUNT ERR	The long range transmitter account generates an error
LRT:ACCOUNT OK	The long range transmitter account is OK
LRT:HARDWARE OK	The long range transmitter hardware is OK
LRT:HARDWRE ERR	The long range transmitter hardware generates an error
LRT:LOW BAT	The long range transmitter is experiencing low battery trouble.
LRT:LOW BAT OK	The long range transmitter low battery in not troubled
LRT:NO BAT	The long range transmitter is experiencing no battery
LRT:NO BAT OK	The long range transmitter no battery is not troubling.
LRT:SYSTEM ERR	The long range transmitter is generating a system error.

Event Message	Description
LRT:SYSTEM OK	The long range transmitter system status is OK
Main Bell RS	Bell trouble restore in Main Panel
Main:AC Rstr	AC power restore on main panel
Main Aux Rst	Restore of Aux power on Main Panel
Main: Bat Rst	Low battery trouble restore from the main panel
Main: Low AC	Loss of AC power from the main panel
Main: Low Bat	Low battery trouble from the main panel
Main:No aux	Failure in the Aux power on Main Panel
Main:No bell	Bell trouble in Main Panel
Masked Z=XX	Anti mask trouble from zone XX
MS=y call error	Communication fail trouble to MS phone no. Y
MS=y restore	Communication fail trouble restore to MS phone no. Y
MW restore z=xx	Trouble restore in the MW channel of BUZ zone XX
MW trouble z=xx	Trouble in the MW channel of BUZ zone XX
Next arm:p=y	Partition Y armed in Next Arm mode
Next dis:p=y	Partition Y disarmed in Next Disarm mode
No aux ps=y	Failure in the Aux power on power supply ID=X
No aux ze=y	Failure in the S. Aux power on zone expander Y
No bell ps=y	Bell trouble in power supply ID=Y
No Com IPC	Communication failure between the LightSYS Plus and IP card
No com kp=y	Communication failure between the LightSYS Plus and keypad ID=Y
No com kr=y	Communication failure between the LightSYS Plus and Key Reader ID=Y
No com voice	Communication failure between the LightSYS Plus and the Advanced Voice module
No com WME=y	Communication failure between the LightSYS Plus and wireless module expander ID=Y
No comm BZE=y	Communication failure between the LightSYS Plus and bus zone expander ID=Y
No comm PS=y	Communication failure between the LightSYS Plus and power supply Y
No comm Siren=y	Communication failure between the LightSYS Plus and siren Y
No comm uo=y	Bus communication failure with UO expander ID=Y
No comm z=xx	Bus communication failure with Bus zone XX
No comm ze=y	Bus communication failure with zone expander ID=Y

Event Message	Description
No comm. GSM	No communication between the GSM/GPRS/3G/4G Module and the LightSYS Plus
No comm. LRT	No communication between long range transmitter and system
No fault z=xx	Trouble restore in zone XX (TEOL zone or Bus zone input TEOL)
No jam wme=y	Jamming restore on wireless module expander ID=Y
No mask z=xx	Anti mask trouble restore from zone XX
Nxt hom:p=y	Partition Y is armed in Next Stay mode
Overld rs ps=y	Overload restore from 3A SMPS Y
Overload ps=y	Overload from 3A SMPS Y
Phone fail	If the phone line is cut or the DC level is under 1V
Phone restore	Phone line trouble restore
PIR rstr Z=xx	PIR trouble restore from Bus zone XX
PIR trbl Z=xx	PIR trouble from Bus zone XX
Police KF=yy	Police (panic) alarm from remote control YY
Police KP=y	Police (panic) alarm from keypad Y
POT.LD RS PS=y	Potential overload restore of 3A SMPS joined by 3A SMPS Y
POT.OVRLD PS=y	Potential overload of SMPS joined by 3A SMPS Y
PROX FAIL S=y	Fail in the proximity anti approach protection in siren Y
PROX OK SIREN=y	Proximity anti approach protection is restored in siren Y
PROX TMP RS S=y	Proximity tamper restore from siren ID =Y
PRX TMP SIREN=y	Proximity tamper from approaching siren ID=Y
PS=yOVER.R C=zz	Overload in 3A SMPS Y. Reset by user ZZ
Radio l.bat S=y	Radio low battery trouble from siren Y
Radiol.bat rS=y	Radio low battery restore from siren Y
Remote Prog	The system has been programmed from the configuration software
Reset: P=y C=zz	Reset of partition ID=Y and user ID=ZZ
Restore Z=xx	Alarm restore in zone no. XX
Rmt Arm:P=y	Partition Y armed from the configuration software
Rmt Dis:P=y	Partition Y disarmed from the configuration software
RMT Hom:P=y	Partition Y armed in Stay mode from the CS software
SEISMIC OK Z=xx	Seismic Test in bus zone XX has been restored
SEISMIC TR Z=xx	Seismic Test trouble in bus zone XX
Self Fail Z=xx	Bus zone XX has failed the Self Test
Self OK Z=xx	Self Test in bus zone XX has been restored
Siren=\$ Lost	Siren is regarded as lost following supervision test

Event Message	Description
Siren=\$ Lost Rs	The LightSYS Plus received a signal from siren after it has been regarded as lost
Soak fail Z=xx	Zone XX has failed in the soak test
Spec. KP=y	Special alarm from the from wireless keypad Y
Spkr Trbl RS S=y	Speaker low battery restore from siren Y
Spkr Trbl Sir=y	Speaker low battery trouble from siren Y
Spkr l.bat S=y	Speaker low battery trouble from siren Y
Spkr l.batrS=y	Speaker low battery restore from siren Y
Start exit P=y	Exit time started in partition Y
STU=Y Line Rstr	STU adapter Y line restoration
STU=Y Line Trbl	STU adapter Y line trouble
STU=Y R.RESET	STU adapter Y line restoration reset
Tamper BZE=y	Tamper alarm from bus zone expander ID=Y
Tamper Kp=y	Tamper alarm from keypad ID=Y
Tamper LRT	Tamper alarm from long range transmitter
Tamper PS=y	Tamper alarm from power supply Y
Tamper Siren=y	Tamper alarm from wireless siren Y
Tamper UO=y	Tamper alarm from utility output expander Y
Tamper Voice	Tamper alarm from Advanced Voice module
Tamper WME=y	Tamper alarm from wireless module expander Y
Tamper ZE=y	Tamper alarm in zone expander ID=X
Tamper Zn=xx	Tamper alarm from zone no. XX
Tech alarm Z=xx	Alarm from zone XX defined as Technical
Tech rstr Z=xx	Alarm restored from zone XX defined as Technical
TMP RS BZE=y	Tamper alarm restore from bus zone expander ID=Y
TMP RS KP=y	Keypad tamper restore
TMP RS PS=y	Tamper alarm restore from power supply expander ID=Y
TMP RS UO=y	Tamper alarm restore from UO expander ID=Y
TMP RS VOICE	Tamper alarm restore from Advanced Voice module
TMP RS WME=y	Tamper alarm restore from wireless module expander ID=Y
TMP RS ZE=y	Tamper alarm restore in zone expander ID=Y
TMP RS ZN=xx	Tamper alarm restore on zone XX
TMP RST LRT	Long Range transmitter tamper alarm reset
Tmp rst Siren=y	Tamper alarm restore from wireless siren Y
Unbyp Box+Bell	Box + Bell reinstated from bypass
Unbyps Zn=xx	Zone no. XX is reinstated from bypass
Unknown evnt	Unknown event alert

Event Message	Description
UO REST ZN=xx	A zone defined as “UO Trigger” has been deactivated
UO TRIG ZN=xx	A zone defined as “UO Trigger” has been activated
VOC:COMM OK	Bus communication OK with Voice Module
VOC:NO COMM	Bus communication failure with the Voice Module
Water Alrm Zn=xx	Flood alarm from zone no. XX
Water rstr Z=xx	Flood alarm restore on zone no. XX
WEAK BAT PS=y	Weak battery indication joined by 3A SMPS Y
Weak Bat RS PS=y	Weak battery restore indication joined by 3A SMPS Y
Z=xx aut bad	Zone self-test failed, zone no. XX
Z=xx auto ok	Zone self-test OK, zone no. XX

Appendix D: Troubleshooting

Troubleshooting and diagnostics can be done by performing by the various systems tests that are available (see *Testing the System*, page 227) and with the Configuration Software. Additional information is available through RISCO University. For additional assistance, contact RISCO Group Technical Support.

LED Indicators – Main Panel PCB, Communication Modules

Main Panel PCB LEDs

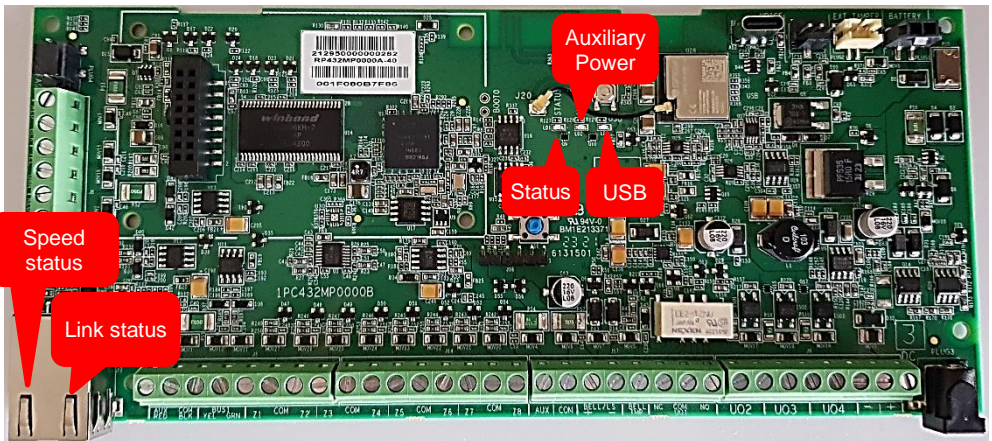

LED/Function	Color	State	Status
LED (Status)	Green	ON	System Ready
		OFF	System Not Available
		Blink slow	Bus test/installation mode
		Blink fast	Upgrade mode
Auxiliary Power Fail LED	Orange	ON	Power Fail (to all bus lines/zones)
		OFF	Power OK
LED (USB)	Blue	ON	USB connection established
		OFF	USB disconnected
		Blink slow	TX/RX active
		Blink fast	
IP RJ45 Speed status	Orange	ON	100Mb/s
		OFF	10Mb/s

LED/Function	Color	State	Status
			(If connected to hub/switch that supports only 10Mb/s)
IP RJ45 Link status	Green	ON	Uplink
		OFF	Downlink
		Blink	TX/RX active

GSM Module LEDs



Note

After 15 minutes all LEDs will turn off.

LED/Function	State	Status	
LD1	(not in use)		
LD2	ON	Module is ON	
	OFF	Module is OFF	
LD3	ON	Communicating with the main panel PCB	
	OFF	No communication with the main panel PCB	
LD4	ON	Voice call: Connected to remote party. -OR- Data call: Connected to remote party or exchange of parameters while setting up or disconnecting a call.	
	OFF	Module is OFF	
	Blink slow	600 ms ON / 600 ms OFF:	1. No SIM 2. No PIN 3. Network search in progress 4. Ongoing user authorization 5. Network login in progress
		500 ms ON / 25 ms OFF:	Packet switch data in progress
Blink fast	75 ms ON / 3 sec OFF:	Registered to GSM network	

Appendix E: Library Voice Messages

001	(Custom)
002	(Custom)
003	(Custom)
004	(Custom)
005	(Custom)

A	
006	A
007	Above
008	Air conditioner
009	An
010	And
011	Apartment
012	Area
013	At
014	Attic

B	
015	Baby's room
016	Back
017	Balcony
018	Basement
019	Bathroom
020	Bedroom
021	Before
022	Behind
023	Bottom
024	Boy's room
025	By

C	
026	Camera
027	Ceiling
028	Cellar
029	Central
030	Children
031	Cleaner
032	CO
033	Computer room
034	Contact
035	Control
036	Corner
037	Curtain

D	
038	Desk
039	Detector
040	Device
041	Dining
042	Door
043	Down
044	Downstairs
045	Dressing

E	
046	East
047	Elevator
048	Emergency
049	Entrance
050	Entry
051	Executive
052	Exit
053	External

F	
054	Family
055	Fence
056	Fire
057	First
058	Flood
059	Floor
060	For
061	Foyer
062	Front

G	
063	Game
064	Garage
065	Garden
066	Gas
067	Gate
068	Girl's room
069	Glass
070	Guest

H	
071	Hallway
072	High

I	
073	In
074	Indoor
075	Inside
076	Internal
077	Is

K	
078	Keyfob
079	Kitchen

L	
080	Landing
081	Left
082	Library
083	Light
084	Living
085	Lobby
086	Low

M	
087	Macro
088	Magnet
089	Main
090	Master
091	Middle
092	Motion

N	
093	Near
094	New
095	North
096	Nursery

O	
097	Of
098	Office
099	On
100	Outdoor
101	Output
102	Outside

P	
103	Panic
104	Partition
105	Passage
106	Patio
107	Perimeter
108	Pool

R	
109	Rear
110	Reception
111	Refrigerator
112	Relay
113	Right
114	Roof
115	Room

S	
116	Safe
117	Safety
118	Second
119	Sensor
120	Shock
121	Shop
122	Shutter
123	Side
124	Siren
125	Site
126	Smoke
127	South
128	Sprinkler
129	Stairs

130	Store
131	Student room
132	Study

T	
133	Technical
134	Temperature
135	Third
136	To
137	Top
138	TV

U	
139	Under
140	Up
141	Upstairs

V	
142	Video camera

W	
143	Wall
144	Warehouse
145	Washroom
146	West
147	Window

Y	
148	Yard

Z	
149	Zone

Numbers	
150	0
151	1
152	2
153	3
154	4
155	5
156	6
157	7
158	8
159	9



Appendix F: Monitoring Station Report Codes

Parameter	Contact ID	SIA	Report Category
Alarms			
Panic alarm	120	PA	Urgent
Panic alarm restore	120	PH	Urgent
Fire alarm	115	FA	Urgent
Fire alarm restore	115	FH	Urgent
Medical alarm	100	MA	Urgent
Medical alarm restore	100	MH	Urgent
Duress alarm	121	HA	Urgent
Duress alarm restore	121	HH	Urgent
Box tamper	137	TA	Urgent
Box tamper restore	137	TR	Urgent
Confirmed alarm	139	BV	Urgent
Confirmed alarm restore	139		Urgent
Confirmed hold up alarm			Urgent
Confirmed hold up alarm restore			Urgent
Recent Close	459		Non-urgent
Main Troubles			
Bell trouble	321	YA	Non-urgent
Bell trouble restore	321	YH	Non-urgent
Auxiliary failure	300	YP	Non-urgent
Auxiliary restore	300	YQ	Non-urgent
Bus failure	333	ET	Non-urgent
Bus restore	333	ER	Non-urgent
Low battery	302	YT	Non-urgent
Low battery restore	302	YR	Non-urgent
AC loss	301	AT	Non-urgent
AC restore	301	AR	Non-urgent
Clock not set	626		Non-urgent
Clock set	625		Non-urgent
False code	421	JA	Non-urgent
False code restore	421		Non-urgent

Parameter	Contact ID	SIA	Report Category
Main phone trouble	351	LT	Non-urgent
Main phone trouble restore	351	LR	Non-urgent
RF Jamming	344	XQ	Non-urgent
RF Jamming restore	344	XH	Non-urgent
GSM trouble	330	IA	Non-urgent
GSM trouble restore	330	IR	Non-urgent
GSM Pre-Alarm			Non-urgent
IP Network trouble			Non-urgent
IP Network trouble restore			Non-urgent
Arm/Disarm			
User Arm	401	CL	Arm/Disarm
User Disarm	401	OP	Arm/Disarm
Stay arm	441	CG	Arm/Disarm
Disarm after alarm	458	OR	Arm/Disarm
Keyswitch Arm	409	CS	Arm/Disarm
Keyswitch Disarm	409	OS	Arm/Disarm
Auto Arm	403	CA	Arm/Disarm
Auto Disarm	403	OA	Arm/Disarm
Remote Arm	407	CL	Arm/Disarm
Remote Disarm	407	OP	Arm/Disarm
Forced Arm	574	CF	Arm/Disarm
Quick Arm	408	CL	Arm/Disarm
Auto Arm fail	455	CI	Arm/Disarm
Detectors (Zones)			
Burglary alarm	130	BA	Urgent
Burglary alarm restore	130	BH	Urgent
Fire alarm	110	FA	Urgent
Fire alarm restore	110	FH	Urgent
Foil alarm	155	BA	Urgent
Foil alarm restore	155	BH	Urgent
Panic alarm	120	PA	Urgent
Panic alarm restore	120	PH	Urgent
Medical alarm	100	MA	Urgent
Medical alarm restore	100	MH	Urgent

Parameter	Contact ID	SIA	Report Category
24 Hour alarm	133	BA	Urgent
24 Hour alarm restore	133	BH	Urgent
Entry/Exit	134	BA	Urgent
Entry/Exit restore	134	BH	Urgent
Water (Flood) alarm	154	WA	Urgent
Water (Flood) alarm restore	154	WH	Urgent
Gas alarm	151	GA	Urgent
Gas alarm restore	151	GH	Urgent
Carbon Monoxide alarm	162	GA	Urgent
Carbon Monoxide alarm restore	162	GH	Urgent
Low Temperature (Freeze alarm)	159	ZA	Urgent
Low Temperature restore	159	ZH	Urgent
High Temperature	158	KA	Urgent
High Temperature restore	158	KH	Urgent
Zone trouble	380	UT	Urgent
Zone trouble restore	380	UJ	Urgent
Burglary trouble	380	BT	Urgent
Burglary trouble restore	380	BJ	Urgent
Zone bypass	570	UB	Urgent
Zone bypass restore	570	UU	Urgent
Burglary bypass	573	BB	Urgent
Burglary bypass restore	573	BU	Urgent
Zone supervision loss	381	UT	Urgent
Zone supervision restore	381	UJ	Urgent
Tamper	144	TA	Urgent
Tamper restore	144	TR	Urgent
Zone lost	381	UT	Urgent
Zone lost restore	381	UJ	Urgent
Low battery	384	XT	Non-urgent
Low battery restore	384	XR	Non-urgent
Soak fail	380	UT	Urgent
Soak fail restore	380	UJ	Urgent

Parameter	Contact ID	SIA	Report Category
Zone Alarm	134	BA	Urgent
Zone Alarm restore	134	BH	Urgent
Zone confirm alarm	139	BV	Urgent
Zone confirm alarm restore	139		Urgent
No activity	393	NC	Urgent
No activity restore	393	NS	Urgent
Wireless Keypad			
Tamper	145	TA	Urgent
Tamper restore	145	TR	Urgent
Keypad lost	355	BZ	Urgent
Keypad lost restore	355		Urgent
Keypad low battery	384	XT	Non-urgent
Keypad low battery restore	384	XR	Non-urgent
Wireless Keyfob			
Arm	409	CS	Arm/Disarm
Disarm	409	OS	Arm/Disarm
Low battery	384	XT	Non-urgent
Low battery restore	384	XR	Non-urgent
Wireless Siren			
Tamper	145	TA	Urgent
Tamper restore	145	TR	Urgent
Low battery	384	XT	Non-urgent
Low battery restore	384	XR	Non-urgent
Siren bell trouble	321	YA	Non-urgent
Siren bell trouble restore	321	YH	Non-urgent
Siren lost	355	BZ	Urgent
Siren lost restore	355		Urgent
Siren auxiliary failure	300	YP	Non-urgent
Siren auxiliary restore	300	YQ	Non-urgent
Power Supply			
Bell trouble	321	YA	Non-urgent
Bell trouble restore	321	YH	Non-urgent
PS low battery	302	YT	Non-urgent
PS low battery restore	302	YR	Non-urgent

Parameter	Contact ID	SIA	Report Category
AC loss	301	AT	Non-urgent
AC restore	301	AR	Non-urgent
Auxiliary failure	300	YP	Non-urgent
Auxiliary restore	300	YQ	Non-urgent
Overload	312	YP	Non-urgent
Overload restore	312	YQ	Non-urgent
PS tamper	144	TA	Urgent
PS tamper restore	144	TR	Urgent
Miscellaneous			
Enter programming (local)	627	LB	Arm/Disarm
Exit programming (Local)	628	LS (LX)	Arm/Disarm
Enter programming (Remote)	627	RB	Arm/Disarm
Exit programming (Remote)	628	RS	Arm/Disarm
MS periodic test	602	RP	Non-urgent
MS keep alive (polling)	999	ZZ	Urgent
System reset	305	RR	Urgent
Listen in begin	606	LF	Urgent
Cancel Report	406	OC	Urgent
Walk Test	607	BC	Non-urgent
Walk Test restore	607		Non-urgent
Exit Error	374		Non-urgent
Enter Service Mode	393	LB	Non-urgent
Exit Service Mode	393	LX	Non-urgent
Fail Cloud Communication			Non-urgent

Appendix G: Remote Software Upgrade

This appendix explains how to perform remote upgrade of your LightSYS Plus main panel software using the LightSYS Plus keypad or SMS command. Remote software upgrade is performed via IP or GPRS/3G/4G.

Notes

1. It is recommended to perform the upgrade process from keypad 1 (not from a wireless keypad).
2. Software upgrade does not delete all previous parameters of the panel.

Step 1: Set parameters for IP/GPRS/3G/4G communication

Define all parameters required to set GPRS/3G/4G or IP communication as explained in the Communication section of the LightSYS Plus (See *page 158*).

Step 2: Enter the location of the firmware update file

- Go to: **1 → 8** (installer **Programming menu → System → Firmware Update**), and enter the relevant information regarding the location of the F/W update file:
 - ❶ **Server IP:** Enter the IP address of the router/gateway where the F/W update file is located. Default: **firmware.riscogroup.com**
 - ❷ **Port:** Enter the port on the router/gateway where the F/W update file is located. Default: **00080**
 - ❸ **File Name:** Enter the F/W update file name. Default: **CMD.TXT**

Notes

1. The file name is case sensitive.
2. Please contact RISCO Group Customer Support services for the file name parameters.

Step 3: Activate the Remote Upgrade from the keypad

1. Go to: **1 → 8 → 4** (installer **Programming menu → System → Firmware Update → Download File**).
2. Select the communication path as follows:
 - ❶ **Via IP**
 - ❷ **Via GPRS**

Notes

Each option appears only if the relevant module (IP or GPRS/3G/4G module) is installed in the system.

If your panel is equipped with an IP or GSM module you can start the download file procedure by sending an SMS command to the panel in the following format:
(If address and port are configured and updated)

- a. Via IP 97239637777IPFILE.
- b. Via GSM (GPRS/3G/4G) 97239637777GSMFILE.

(Address and port can be added to the SMS command string as per the following. If specified, these parameters also override any existing panel settings)

- a. Via IP 97239637777IPFILE10.10.10.6:80.
- b. Via GSM (GPRS/3G/4G) 97239637777GSMFILE212.150.25.223:80.

3. Once selected, the LightSYS Plus will start downloading the required files. The upgrade procedure may take approximately 40 minutes to complete. This will vary according to whether the procedure is performed via GPRS/3G/4G or IP. Once the files are downloaded the panel automatically starts with the upgrade procedure of the units connected to the system.

Notes

- During the upgrade process of the panel firmware there will be no display on the keypad.
- While downloading the files for the upgrade procedure the green STATUS LED on the main panel PCB will flash slowly. When the upgrade procedure starts, it will start to flash rapidly.

Step 4: Verify the upgrade was successful

1. From the main display press **Exit** () and enter the installer code followed by **OK** (✓).
2. Scroll to **Maintenance → Diagnostics → Panel Version**. The upgraded version of the main panel will appear.
3. To view the other accessories version navigate to the required menus under the **Maintenance → Diagnostics** menu.

Note

If upgrade has failed, the previous software version of the main panel / accessory version will appear.

Appendix H: Compliance

Possible logical key calculations

- Logical codes are codes punched in the wireless keypad to allow Level 2 (users) and Level 3 (installer) access.
- All codes - 6 digits structure: xxxxxx
- 0-9 can be used for each digit.
- There are no disallowed codes - codes from 000001 to 999999 are acceptable.
- Invalid codes cannot be created due to the fact that after the code 4th digit has been punched, "Enter" is automatically applied. Code is rejected when trying to create a non-existing code.

Possible physical key calculations

- Physical keys are implemented in the wireless keyfobs.
- It is assumed that only a user possesses a keyfobs, therefore a physical key is considered as access Level 2
- Each keyfob has 24 bit identification code comprising 2^{24} options.
- A keyfob has to be recognized and registered by the LightSYS Plus, therefore, a "write" process must be performed.
- A valid keyfob is one "Learned" by the panel and allowing arm/disarm
- A non-valid keyfob is one not "learned" by the panel and not allowing arm/disarm.

System Monitoring

- The main unit is monitored for AC trouble, battery fault, low battery and more.
- All other wireless elements are monitored for low voltage battery.

Setting the LightSYS Plus to comply with EN 50131 Requirements

1. Access the Installer programming mode.
2. From the ① System menu select ⑤ to access the Settings menu.
3. From the Settings menu select ④ to access the Standard option.
4. Select EN 50131. Once selected, the following changes will occur in the LightSYS Plus software:

Feature	EN 50131 Compliance	
Timers	Quick Key	Required Value:
Entry Delay	①①①① ①, ①①①② ①	45 seconds (maximum allowed)
AC Delay	①①①② ⑦	Immediate (0 minutes)
RX Supervision	①①①⑥ ②	2 hours
System Controls	Quick Key	Required Value:
Quick Arm	①②① ①①	Set to NO
False Code Trouble	①②① ①⑤	Set to Yes
Forced Arming	①②① ①②	Set to NO
Authorize installer	①②④ ①①	Set to YES
Override Trouble	①②④ ①②	Set to NO
Restore Alarm	①②④ ①③	Set to YES
Mandatory Event Log	①②④ ①④	Set to YES
Restore Trouble	①②④ ①⑤	Set to YES
Exit Alarm	①②④ ①⑥	Set to NO
Entry Alarm	①②④ ①⑦	Set to YES
20 minutes signal	①②④ ①⑧	Set to YES
Attenuation	①②④ ①⑨	Set to YES

- After configuring the system to EN 50131, indications are made inaccessible and the display will show only “Enter code:”
To show indications, you must enter a valid code.
- After entering 3 invalid user codes, an 'invalid code' signal will be alerted to the monitoring station and recorded in the event log. The invalid code will continue to alert in the system until restored by a user with a code

Appendix I: LightSYS Plus Accessories

Part number	Description	Comments
Main Panel		
RP432MP0000A	LightSYS Plus Main Board	
Enclosures		
RP432BP2000A	LightSYS+,Small Plastic Box+TMP	
RP432BP3000A	LightSYS+,Base+Metal Cover+TMP	
RP432BP4000A	LightSYS+,Large Plastic Box+TMP	
Communication Modules		
RP432G200GLA	2G for LightSYS Plus+Ant,GL	Multi-Socket 2G with Antenna for Plastic Box
RP432G400USA	LightSYS Plus,4G Module+Ant,US	Multi-Socket 4G with Antenna for Plastic Box
RP432G400EUA	LightSYS Plus,4G Module+Ant,EU	Multi-Socket 4G with Antenna for Plastic Box
RP432G400AUA	LightSYS Plus,4G Module+Ant,AU	Multi-Socket 4G with Antenna for Plastic Box
RP432G400LAA	LightSYS Plus,4G Module+Ant,LA	Multi-Socket 4G with Antenna for Plastic Box
RC432WIFI00A	LightSYS Plus WiFi Ext ANT+CBL	
RC432GSM4G0A	LightSYS Plus 4G ANT+CBL	
Keypads		
RPKEL0WT000A	Elegant Keypad, White	
RPKELPWT000B	Elegant Keypad, White W/Prox	
RPKEL0B0000A	Elegant Keypad, Black	
RPKELPB0000B	Elegant Keypad, Black w/ Prox	
RP432KP0000A	LightSYS LCD Keypad	
RP432KPP000A	LightSYS LCD Keypad + Prox	
RP128PKR300A	Prox Key Reader Kit 13.56 MHz	
RP432KPT000A	RisControl IPS Touchscreen KP	
RP432KPP200D	Panda Wired Keypad, Prox.	
RP432KP0200C	Panda Wired Keypad	
Wired Bus Accessories		
RP432EZ8000C	8 Zone Expander	X63 per system, x32 per bus
RP128EZB000B	Bus Zone Expander	x32 per system, x16 per bus
RP128EZ0100A	Single Zone Expander	
RP296E04000A	4 Relay Outputs + IMQ	

Part number	Description	Comments
RP128EPS000A	Switched Mode Power Supply -3A	
RP128PSPSEUA	3A_SMPS+LargeBox+TRS+TMP	
RP432EV0001C	LightSYS Voice Multi-language	
RP432EV001TB	Voice Module, IT,DE	
RW132EVL000A	Voice Listening	
Wired Bus Detectors & Sirens		
RK515DTBGL0A	BWare Bus DT Grade 2, 15m	
RK515DTBG30A	BWare Bus DT AM Grade 3, 15m	
RK500QBG300A	BWare Bus QUAD AM Grade 3	
RK500QB0000A	BWare Bus QUAD Grade 2	
RK315DT0000C	WatchOUT Extreme DT + swivel	
RK107DTB000A	Wired Curtain DT AM, Bus	
RK107DTB000B	Wired Curtain DT AM,Bus+Swivel	
RK350DT0000B	Beyond DT, Anti Mask	
RK200DTG300D	Ind. LuNAR DT AM G3	
RK200DTG3USE	Ind. LuNAR DT AM G3, US	
RK200DTG3USB	IND. LUNAR DT AM G3, US	
RK66SW00000B	Seismic without MP & Tester	
RK66S000000B	Seismic with MP & Tester	
RK66M000000A	Mounting Plate for Seismic	
RK66K000000A	Keyhole Protection for Seismic	
RK66T000000A	Test Generator for Seismic	
RS200WAP000B	ProSound with Proximity	
RS200WA0000B	ProSound	
RS200LW0000A	ProSound External Lamp	
RS402CB0000A	Lumin8 Delta Cover, Blue	
Wireless Devices		
RP432EWV800A	2-Way Wireless Video Expander	Wireless Video Expander 868/869MHz
RP432EWV800B	2-Way Wireless Video Expander	Wireless Video Expander 868/869MHz
RP432EWV400A	2-Way Wireless Video Expander	Wireless Video Expander 433/916MHz
RP432EWV440A	2-Way Wireless Video Expander	Wireless Video Expander 433/430MHz
RP432EWS800A	2-Way Wireless Security Module	Wireless Security Module 868MHz

Part number	Description	Comments
RW132KL1P00A	2-Way Black Ext. WL Slim KP+Prox	Black Proximity keypad 868 MHz
RW132KL2P00A	2-Way White Int. WL Slim KP+Prox	White Proximity keypad 868 MHz
RW132KL2P00H	2-Way White Int. WL Slim KP, 433 MHz	Black Proximity keypad 433 MHz
RW132KL1P00H	2-Way Black Ext. WL Slim KP, 433 MHz	Outdoor White Proximity keypad 433 MHz
RP432EW8000A	2 Zone Wireless Receiver, 868 MHz	
RP432EW4000A	32 Zone Wireless Receiver, 433 MHz	
RWX515PT080A	2 Way WL BWare Pet, 868 MHz	
RWX515PR080A	2 Way WL BWare PIR, 868MHz	
RWX515DTP80A	2 Way WL BWare DT Pet, 868 MHz	
RWX515DT080A	2 Way WL BWare DT, 868 MHz	
RWX515PT040A	2 Way WL BWare Pet, 433 MHz	
RWX515PR040A	2 Way WL BWare PIR, 433 MHz	
RWX515DTP40A	2 Way WL BWare DT Pet, 433 MHz	
RWX515DT040A	2 Way WL BWare DT, 433 MHz	
RWX95086800C	2-Way WL iWAVE PIR, 868 MHz MHz	
RWX95P86800C	2-Way WL iWAVE Pet, 868 MHz	
RWX95DT0800B	2 Way WL iWave DT, 868 MHz	
RWX95DTP800B	2 Way WL iWave DT Pet, 868 MHz	
RWT312PR400B	WL WatchOUT PIR, 433 MHz	
RWX312PR400B	2-Way WL WatchOUT PIR, 433 MHz	
RWX10680000A	1 & 2-Way WL Curtain PIR, 868 MHz	
RWX10680200A	2-Way WL Curtain PIR, 868MHz	
RWX10640000A	1 & 2-Way WL Curtain PIR, 433 MHz	
RWX10640200A	2-Way WL Curtain PIR, 433MHz	
RWX73F8BL00C	2-Way Multi Contact,868, Black	
RWX96043300B	1&2 Way WL Piccolo PIR 433 MHz	
RWX96040200A	2 Way WL Piccolo PIR 433MHz	
RWX96P40200A	2 Way WL Piccolo PET 433MHz	
RWX96C40200A	2 Way WL Piccolo PIR 433MHz	

Part number	Description	Comments
RWX96086800B	1&2 Way WL Piccolo PIR 868 MHz	
RWX96080200A	2 Way WL Piccolo PIR 868MHz	
RWX96C80200A	2 Way WL Piccolo PIR 868MHz	
RWX96P86800A	1&2 Way WL Piccolo Pet 868 MHz	
RWX96P80200A	2 Way WL Piccolo Pet 868MHz	
RWX73M8BR00B	2-Way Door/Win Contact, 868 MHz, Brown	
RWX73M8BL00D	2-Way Door/Win Contact, 868 MHz, Black	
RWX73M86800D	2-Way Door/Window Contacts, 868 MHz	
RWX73F8BR00C	2-Way Multi Contact, 868 MHz, Brown	
RWX107DT800A	WL Outdoor DT Curtain 868 MHz	
RWX107DT800B	WL Outdoor DT Curtain 868+Swivel	
RWX107DT400A	WL Outdoor DT Curtain 433 MHz	
RWX107DT400B	WL Outdoor DT Curtain 433+Swivel	
RWX73F86800C	2Way Multi-Function Contacts, 868 MHz	
RWX350D0800A	WL Beyond DT, 868 MHz	
RWX350DC800B	WL Beyond DT Cam, 868.65/869.525 MHz	
RWX350D0400A	WL Beyond DT, 433MHz	
RWX350DC400B	WL Beyond DT Cam, 433/916MHz	
RWX73M43300D	2Way Door/Window Contacts, 433 MHz	
RWX73F43300A	2Way Multi-Function Contacts, 433 MHz	
RWX73F43300C	433 MHz	
RWX34S86800B	Smoke & Heat Detector1&2 Way, 868 MHz	
RWX34S43300B	Smoke & Heat Detector1&2 Way 433 MHz	
RWX780868M3A	2-way Slim Contact X73 868MHz	
RWX35S00400C	WL Smoke & Heat, 433 MHz	
RWX35S00800C	WL Smoke & Heat, 868 MHz	
RWT6GS41100A	WL GAS Detector 433 MHz, 110V	

Part number	Description	Comments
RWT6FW86800B	WL Flood Detector 868 MHz	
RWT6FW43300B	WL Flood Detector 433 MHz-White	
RWX132KF800A	2-Way WL Remote Control, 868 MHz	
RWX332KF800B	Panda 2Way KeyFob 868MHz	
RWX332KF400A	Panda 2Way KeyFob 433MHz	
RWT52P86800A	2 Button Panic Keyfob, 868 MHz	
RWT52P43300A	2 Button Panic Keyfob, 433 MHz	
RWT51P80000A	Wristband Panic Transmitter, 868 MHz	
RWS42086800B	WL Indoor Sounder, 868 MHz, Round	
RWS42043300B	WL Indoor Sounder, 433 MHz, Round	
Wireless External Sirens		
RWS50B868UKA	WL External Sounder, Blue 868 MHz UK	
RWS20A86800B	Wireless ProSound, 868 MHz	
RWS401A8000B	WL Lumin8, Amber 868 MHz	
RWS401B4000B	WL Lumin8, Blue, 433 MHz	
RWS401B8000B	WL Lumin8, Blue 868 MHz	
RWS401R8000B	WL Lumin8, Red, 868MHz	



Appendix J: Installer Programming Maps

Installer Programming Menu

1) System			
1) Timers			
	01) Ex/En Delay 1		
	02) Ex/En Delay 2		
	03) Bell Timeout		
	04) Bell Delay		
	05) Switch Aux Break		
	06) Wireless		
	07) AC Off Delay		
	08) Guard Delay		
	09) Swinger Limit		
	10) Redial Wait		
	11) Last Exit Sound		
	12) Buzzer at Stay		
	13) Status Timer		
	14) Service Timer		
	16) Pulse Open		
	17) Inactivity Timer		
	18) T.O. Beeps		
2) Controls			
	1) Basic		
		01) Quick Arm	
		02) Quick UO	
		03) Allow Bypass	
		04) Quick Bypass	
		05) False Code Trouble	
		06) Bell Squawk	
		07) 3 Minute Bypass	
		08) Audible Panic	
		09) Buzzer → Bell	
		10) Enable Jamming	
		11) Audible Jamming	
		12) Ex..St. Beep	
		13) Forced KSW	
		14) Arm Prewrn	
	2) Advanced		
		01) Dbl Verification Fire	
		02) Alarm ZE Cut	
		03) Code Grand Master	
		04) Area	
		05) Global Follow	
		06) Summer/Winter	
		07) 24 Hour Bypass	
		08) Technician Tamper	

		09) Technician Reset	
		10) Engineer Tamper	
		11) Low battery Arming	
		12) Bell 30/10	
		13) Fire Temporal Pattern	
		14) IMQ Install	
		15) Disable Incoming Calls	
		16)Disable. Keypad Auto Arming	
		17) Buzzer Delay	
		18) Speaker=Buzzer	
		19) Confirm Speaker	
		20) Bell Confirmation	
		21) Error Speaker Time On	
		22) AC Trouble Arm	
		23) Strobe Arm	
		24) Final Night	
		25) Stay Strobe	
		26) Blank Display	
		27) Display System Label	
		28) Presence Log Event	
		29) Wireless Lost as Tamper	
	3) Communication		
		1) Monitoring Station Enable	
		2) Follow Me Enable	
		3) CS Enable	
		4) Cloud Enable	
	4) EN 50131		
		1) Authorize Installer	
		2) Override Trouble	
		3) Restore Alarm	
		4) Mandatory Event Log	
		5) Restore Troubles	
		6) Exit Alarm	
		7) Entry Alarm	
		8) 20 minutes signal	
		9) Attenuation	
	5) PD6662		
		1) Bypass Exit/Entry	
		2) Entry Disable	
		3) Route Disable	
		4) Installer Confirmation	
		5) Key switch Lock	
		6) Entry Disarm	
		7) Proximity Disarm	
	6) CP-01		
		1) Exit Restart	
		2) Auto Stay	
	7) Device		
		1) Anti Mask = Tamper	
		2) Proximity Anti Mask =	

		Tamper	
		3) Audible Proximity Tamper	
		4) Siren Aux = Tamp	
		5) Siren Pre-Alarm	
		6) RF wake-up	
		7) KF Instant Arm	
		8) KF Instant Stay	
		9) KF Dis+Code	
3) Labels			
	1) System		
	2) Partitions (1 – 32)		
4) Sounds			
	1) Tamper Sound		
		1) During Disarm	
			1) Silent
			2) Bell only
			3) Buzzer (main) only
			4) Bell + Buzzer
		2) During Arm	
			1) Silent
			2) Bell only
			3) Buzzer (main) only
			4) Bell + Buzzer
	2) Speaker Volume		
		1) Trouble	
		2) Chime	
		3) Exit/Entry	
		4) Alarm	
		5) Squawk	
5) Settings			
	1) Siren Mode		
	2) Default Panel		
		With labels?	
	3) Erase Wireless		
	4) Standard		
		1) EN 50131 (G2)	
		2) PD6662	
		3) CP-01	
		4) EN 50131 (G3)	
		5) Customere	
	5) Customer		
		1) 0EN	
		2) 0IT	
		3) 0IL	
		4) 0HU	
		5) 0UK	
		6) 0SP	
		7) 0PL	
		8) 0GR	
		9) 0BR	

		10) ORU	
		11) ONL	
		12) OFR	
		13) OCN	
		14) ODK	
		15) OCZ	
		16) OAU	
		17) OTH	
		18) ODE	
		19) OIE	
		20) OGT	
	6) Language		
		1) Text	
		2) Voice	
			(language selection)
	7) Partition Quantity		
	8) Bypass Tamper		
6) Automatic Clock			
	1) Server		
		1) NTP	
		2) DAYTIME	
	2) Host		
	3) Port		
	4) Time Zone (GMT)		
7) Service Info.			
	1) Name		
	2) Phone		
8) Firmware Update			
	1) Server IP		
	2) Server port		
	3) File name		
	4) Download Files		
		1) Via IP	
		2) Via GPRS	

2) Zones				
1) Parameters				
	1) One By One			
		Label		
		Partition/s		
		Group/s		
		Type		
			00) Not used	
			01) Exit/Entry 1	
			02) Exit/Entry 2	
			03) Exit(OP)/Entry 1	
			04) Exit(OP)/Entry 2	
			05) Entry Follower	

			06) Instant	
			07) I+ Exit/Entry 1	
			08) I+ Exit/Entry 2	
			09) I+Exit(OP)/Entry1	
			10) I+Exit (OP)/Entry2	
			11) I + Entry Follow	
			12) I+ Instant	
			13) UO Trigger	
			14) Day Zone	
			15) 24 Hours	
			16) Fire	
			17) Panic	
			18) Special	
			19) Key switch	
			20) Final Exit	
			21) Latch Keyswitch	
			22) EN.Foll + Stay	
			23) Pulsed Keyswitch Delay	
			24) Latch Keyswitch Delay	
			25) Tamper	
			26) Technical	
			27) Water	
			28) Gas	
			29) CO	
			30) Exit Term	
			31) High temp	
			32) Low temp.	
			33) Key box	
			34) Keyswitch Arm	
			35) Keyswitch Delayed Arm	
		Arm sound		
			1) Silent	
			2) Bell only	
			3) Buzzer only	
			4) Bell + buzzer	
			5) Door chime	
		Stay sound		
			1) Silent	
			2) Bell only	
			3) Buzzer only	
			4) Bell + buzzer	
			5) Door chime	
		Disarm sound		
			1) Silent	
			2) Bell only	
			3) Buzzer only	
			4) Bell + buzzer	
			5) Door chime	
		Termination		
			1) N/C	

			2) EOL	
			3) DEOL	
			4) N/O	
			5) TEOL	
		Response		
			1) Normal, 400ms	
			2) Long, 1 sec.	
			3) Fast, 10ms	
			4) Extra fast, 1ms	
			5) 0.5 HOURS	
			6) 1 HOURS	
			7) 1.5 HOURS	
			8) 2 HOURS	
			9) 2.5 HOURS	
			10) 3 HOURS	
			11) 3.5 HOURS	
			12) 4 HOURS	
	2) By Category			
		1) Label		
		2) Partition		
		3) Type		
			00) Not used	
			01) Exit/Entry 1	
			02) Exit/Entry 2	
			03) Exit(OP)/Entry 1	
			04) Exit(OP)/Entry 2	
			05) Entry Follower	
			06) Instant	
			07) I+ Exit/Entry 1	
			08) I+ Exit/Entry 2	
			09) I+Exit(OP)/Entry1	
			10) I+Exit (OP)/Entry2	
			11) I + Entry Follow	
			12) I+ Instant	
			13) UO Trigger	
			14) Day Zone	
			15) 24 Hours	
			16) Fire	
			17) Panic	
			18) Special	
			19) Key switch	
			20) Final Exit	
			21) Latch Keyswitch	
			22) EN.Foll + Stay	
			23) Pulsed Keyswitch Delay	
			24) Latch Keyswitch Delay	
			25) Tamper	
			26) Technical	
			27) Water	
			28) Gas	

			29) CO	
			30) Exit Term	
			31) High temp	
			32) Low temp.	
			33) Key box	
			34) Keyswitch Arm	
			35) Keyswitch Delayed Arm	
		4) Sound		
			1) At Arm	
				1) Silent
				2) Bell only
				3) Buzzer only
				4) Bell+buzzer
				5) Door chime
			2) At Stay	
				1) Silent
				2) Bell only
				3) Buzzer only
				4) Bell+buzzer
				5) Door chime
			3) At Disarm	
				1) Silent
				2) Bell only
				3) Buzzer only
				4) Bell+buzzer
				5) Door chime
		5) Termination		
			1) N/C	
			2) EOL	
			3) DEOL	
			4) N/O	
			5) TEOL	
		6) Loop Response		
			1) Normal, 400ms	
			2) Long, 1 sec.	
			3) Fast, 10ms	
			4) Extra fast, 1ms	
			5) 0.5 hour	
			6) 1 hour	
			7) 1.5 hours	
			8) 2 hours	
			9) 2.5 hours	
			10) 3 hours	
			11) 3.5 hours	
			12) 4 hours	
		7) Advanced		
			1) Forced Arming	
				1) Enable
				2) Disable
			2) Pulsed Counter	

			3) Abort Alarm	
				1) Enable
				2) Disable
			4) Bus Zone Parameters	
			5) Wireless Zone Parameters	
			6) Presence	
	3) Resistance			
		00) Custom		
		01) 2.2K, 2.2K		
		02) 4.7K, 6.8K, 12K		
		03) 6.8K, 2.2K		
		04) 10K, 10K		
		05) 3.74K, 6.98K		
		06) 2.7K, 2.7K		
		07) 4.7K, 4.7K		
		08) 3.3K, 4.7K		
		09) 1K, 1K		
		10) 3.3K, 3.3K		
		11) 5.6K, 5.6K		
		12) 2.2K, 1.1K		
		13) 2.2K, 4.7K		
2) Testing				
	1) Self Test			
		1) Times		
		2) Zones		
	2) Soak Test			
3) Cross Zones				
	Zone Crossing			
	Crossing Set			
	Pair			
		1) None		
		2) Ordered		
		3) Not ordered		
4) Alarm confirm				
	1) Confirm partition			
	2) Confirm zones			

3) Outputs			
0) Follows Nothing			
1) Follows System			
	01) Bell follow		
	02) No. Tel Line		
	03) Comm. failure		
	04) Trouble follow		
	05) Low battery follow		
	06) AC loss follow		
	07) Sensors test		
	08) Battery Test		
	09) Bell Burglary		

	10) Scheduler		
	11) Switched Aux		
	12) GSM Error		
	13) Bell Test		
	14) Installation		
	15) Walk Test		
	16) Burglary		
	17) Panic		
	18) Fire		
	19) Special		
	20) 24 Hour		
2) Follows Partition			
	01) Ready follow		
	02) Alarm follow		
	03) Arm follow		
	04) Burglary follow		
	05) Fire follow		
	06) Panic follow		
	07) Special follow		
	08) Buzzer follow		
	09) Chime follow		
	10) Exit/Entry follow		
	11) Fire Trouble		
	12) Day (Zone) Trouble		
	13) Trouble follow		
	14) Stay follow		
	15) Tamper follow		
	16) Disarm follow		
	17) Bell follow		
	18) Bell Stay Off		
	19) Zone Bypass		
	20) Auto Arm Alarm		
	21) Zone Loss Alarm		
	22) Bell Trigger		
	23) Strobe Trigger		
	24) Fail To Arm		
	25) Confirm Alarm		
	26) Duress follow		
	27) HU Confirm Alarm		
	28) STU Alarm		
	29) STU Panic		
	30) STU Fire		
	31) STU Config Alarm		
	32) Zone Exclude		
3) Follows Zone			
	1) Zone Follow		
	2) Alarm Follow		
	3) Arm Follow		
	4) Disarm Follow		
4) Follows Code			

	000) Grand		
	001) User		

4) Codes			
1) User			
	1) Partition		
	2) Authority		
2) Grand Master			
3) Installer			
4) Sub Installer			
5) Code Length			
	1) 4 digits		
	2) 6 digits		

5) Communication				
1) Method				
	1) PSTN			
		1) Timers		
			1) PSTN Lost Delay	
			2) Wait for Dial Tone	
		2) Controls		
			1) Alarm Line Cut	
			2) Answer Machine Override	
		3) Parameters		
			2) Rings to Answer	
			3) Area Code	
			4) PBX Prefix	
			5) Call Wait	
	2) GSM			
		1) Timers		
			1) GSM Lost	
			2) GSM Net Loss	
			3) SIM Expire	
			4) MS Polling	
				1) Primary
				2) Secondary
				3) Backup
		2) GPRS		
			1) APN Code	
			2) APN User Name	
			3) APN Password	
		3) Email		
			1) Mail Host	
			2) SMTP Port	
			3) Email Address	
			4) SMTP User name	
			5) SMTP Password	

		4) Controls	
			1) Caller ID
			2) LED Enable
		5) Parameters	
			1) PIN Code
			2) SIM Number
			3) SMS Center Phone
			4) GSM RSSI
			1) Disable
			2) Low Signal
			3) High Signal
		6) Prepay SIM	
			1) Get Credit by
			1) Credit SMS
			2) Credit Voice
			3) Service Cmnd
			2) Phone To Send
			3) Phone To Receive
			4) SMS Message
	3) IP		
		1) IP Configuration	
			1) Obtain IP
			1) Dynamic ID
			2) Static ID
			2) Panel Port
			3) Panel IP
			4) Subnet Mask
			5) Gateway
			6) DNS Primary
			7) DNS Secondary
			8) Wi-Fi Scan
			9) Add Wi-Fi Net
			10) WPS Button
		2) Email	
			1) Mail Host
			2) SMTP Port
			3) Email Address
			4) SMTP Name
			5) SMTP Password
		3) Host Name	
		4) MS Polling	
			1) Primary
			2) Secondary
			3) Backup
		5) Controls	
	4) LRT		
		1) Account	
		2) System	
		3) Periodic Test	

		4) No Comm Parm		
		5) Control		
			1) Disable Low Battery	
2) Monitoring Station				
	0) MS Mode			
	1) Report Type			
		1) MS 1 2) MS 2 3) MS 3		
			1) Voice	
				1) PSTN/GSM (N/A)
				2) GSM/PSTN (N/A)
				3) PSTN Only (N/A)
				4) GSM Only
			2) IP	
				1) IP/GPRS
				2) GPRS/IP
				3) IP Only
				4) GPRS Only
			3) SMS	
				MS Phone Number
			4)LRT	
			5) SIA IP	
				1) IP/GPRS
				2) GPRS/IP
				3) IP Only
				4) GPRS Only
	2) Accounts			
		1)Partition		
	3) Comm. Format			
		1) Contact ID		
		2) SIA		
	4) Controls			
		1) Call Save		
		2) Show Kissoff		
		3) Show Handshake		
		4) Audible Kissoff		
		5) SIA Text		
		6) Random MS Testing		
		7) SIA w/part		
		8) SIA CH INFO		
	5) Parameters			
		1) MS Retries		
		2) Alarm Restore		
			1) On Bell Time out	
			2) Follow Zone	
			3) At Disarm	
		3) SIA IP Parameters		
			1) MS 1	
			2) MS 2	

			3) MS 3	
				1) Encryption Key
				2) Receiver Number
	6) MS Times			
		1) Periodic Test		
		2) Abort Alarm		
		3) Cancel Delay		
		4) Listen In		
		5) Confirmation		
			1) Confirm Start	
			2) Confirm Time	
	7) Report Split			
		1) MS Arm/Disarm		
			1) Do Not Call	
			2) Call 1st	
			3) Call 2nd	
			4) Call 3rd	
			5) Call All	
			6) 1st Bkup 2nd	
			7) 1st Bk 2nd 3rd	
			8) 1 Bk 3 Call 2	
			9) 2 Bk 3 Call 1	
		2) MS Urgent		
			1) Do Not Call	
			2) Call 1st	
			3) Call 2nd	
			4) Call 3rd	
			5) Call All	
			6) 1st Bkup 2nd	
			7) 1st Bk 2nd 3rd	
			8) 1 Bk 3 Call 2	
			9) 2 Bk 3 Call 1	
		3) MS Non Urgent		
			1) Do Not Call	
			2) Call 1st	
			3) Call 2nd	
			4) Call 3rd	
			5) Call All	
			6) 1st Bkup 2nd	
			7) 1st Bk 2nd 3rd	
			8) 1 Bk 3 Call 2	
			9) 2 Bk 3 Call 1	
	8) Report Codes			
		1) Edit Codes		
			1) Alarms	
				1) Panic
				2) Fire
				3) Medical
				4) Duress
				5) Confirm Alarm

				6) Box Tamper	
				7) Bell Tamper	
				8) Recent Close	
				9) HU Confirm.	
			2) Main Troubles		
				01) Low Battery	
				02) Bell	
				03) Phone trbl	
				04) AC Loss	
				05) Aux	
				06) Clk not set	
				07) Bus trouble	
				08) False code	
				09) GSM trouble	
				10) IP net trbl.	
				11) MS 1 trouble	
				12) MS 2 trouble	
				13) MS 3 trouble	
			3) Arm/Disarm		
				1) User	GM (000 User: (001- - 499)
				2) Automatic	
				3) Remote	
				4) Force Arm	
				5) Quick Arm	
				6) Keyswitch	
				7) Auto Arm Fail	
			4) Zones		
				1) By zone	1) Alarm 2) Trouble 3) Bypass 4) Tamper
				2) Zone lost	
				3) Soak fail	
				4) Self test	
			5) Accessories		
				1) Keypad	1) Tamper
				2) Zone expander	1) Tamper
				3) Utility Output	1) Tamper

				4) Power supply	1) Tamper 2) Low bat 3) Bell 4) AC 5) AUX 6) Overld
				5) Keyfob	1) Arm/Dis 2) Low bat
				6) Voice module	1) Tamper
				7) Sounder	1) Tamper 2) Low bat 3) Bell 4) Aux 5) Lost
				8) WL Expander	1) Tamper 2) Jamm.
				9) Bus Expander	1) Tamper
				10) COB	1) Tamper 2) Low bat 3) AC
			6) Miscellaneous		
					01) Enter prog.
					02) Exit prog.
					03) MS per. test
					04) System reset
					05) Abort alarm
					06) Listen in
					07) MS polling
					08) Cancel report
					09) Walk test
					10) Exit error
					11) Fail Cloud
					12) Ent. Serv. Mod
					13) Ex. Serv. Mod
			2) Delete All		
3) Configuration SW					
	0) CS Mode				
	1) Security				
		1) Access code			
		2) Remote ID			
		3) MS Lock			
	3) Control				
		1) User Initiate			

	4) IP Gateway			
		1) IP Address		
		2) IP Port		
4) Follow Me				
	0) FM Mode			
	1) Define FM			
	(Select FM 01 – 64)			
		1) Report Type		
			1) Voice	
				1) PSTN/GSM 2) GSM/PSTN 3) PSTN only 4) GSM only
			2) Email	
				1) IP/GPRS 2) GPRS/IP 3) IP only 4) GPRS only
			3) SMS	
		2) Partition		
		3) Events		
			1) Alarms	
				1) Intruder alarm
				2) Fire alarm
				3) Emergency alarm
				4) Panic alarm
				5) Tamper alarm
				6) Duress alarm
				7) Confirm alarm
			2) Arm/Disarm	
				1) Arm
				2) Disarm
			3) Troubles	
				01) False code
				02) Main low battery
				03) WL low battery
				04) Jamming
				05) WL lost
				06) AC off
				07) Bell trouble
				08) Bus trouble
				09) Siren low battery
				11) IP network
			4) GSM	
				1)GSM trouble
				2)SIM trouble
				3)SIM expire
				4)SIM credit
			5) Environmental	
				1) Gas alert
				2) Flood alert

				3) CO alert
				4) High temp.
				5) Low temp
				6) Technical
			6) Miscellaneous	
				1) Zone bypass
				2) Periodic test
				3) Remote programming
		4) Restore Events		
			1) Alarms	
				1) Intruder alarm
				2) Tamper alarm
			2) Troubles	
				01) Main low battery
				02) WL low battery
				03) Jamming
				04) WL lost
				05) AC off
				06) Bell trouble
				07) Bus trouble
				08) Siren low battery
				09) PSTN Trouble
				10) IP network
			3) GSM	
				1) GSM trouble
			4) Environmental	
				1) Gas alert
				2) Flood alert
				3) CO alert
				4) High temperature
				5) Low temperature
				6) Technical
		5) Remote Control		
			1) Remote Listen	
			2) Remote Program	
	2) Controls			
		1) Disarm Stop FM		
		2) Disbl. report at Stay		
	3) Parameters			
		1) FM retries		
		2) Voice msg. recurrence		
		3) Periodic Test		
5) Cloud				
	0) Cloud Mode			
	1) IP Address			
	2) IP Port			
	3) Password			
	4) Channel			
		1) IP Only		

		2) GSM Only		
		3) IP/GSM		
		4) GSM/IP		
	5) Controls			
		1)MS Call All		
		2)FM Call All		
		3)App Arm		
		4)App Disarm		
		5)App Exit Delay		
		6) Encryption		

6) Audio				
1) Messages				
	1) Common message			
		1) Play		
		2) Record		
	2) Zone			
		1) Play		
		2) Assign message		
	3) Partition			
		1) Play		
		2) Assign message		
	4) Output			
		1) Play		
		2) Assign message		
	5) Macro (A,B,C,D)			
		1)Play		
		2)Assign message		
	6) Library msg (1-5)			
		1) Play		
		2) Record		
2) Local Announce				
	1) Intruder			
	2) Fire Alarm			
	3) Emergency			
	4) Panic Alarm			
	5) Tamper Alarm			
	6) Environmental			
	7) Away Alarm			
	8) Stay Alarm			
	9) Disarm			
	10) Audible St.			
	11) Entry/exit			
	12) Auto Arm			
	13) Output			
	14) Walk Test			
7) Install				

1) Bus Device				
	1)Automatic (bus scan)			
	2)Manual			
		01) Keypad (number/type, delete)		
			Assign to partition(s)	
			Masking	
			Emergency	
		02) Zone Expander (number/type, delete)		
			Resistance	
		03) Utility Output (number/type, delete)		
		04) Power Supply (number/type, delete)		
			Partition(s)	
				1) Bell/Loudspeaker
		05) Wireless Expander (number/type, delete)		
			Box tamper	
		06) Prox. Key Reader (number/type, delete)		
			Partition(s)	
				1) Instant Arm
				2) Show ready?
				3) Show arm?
				4) Show stay?
				5) Show bypass?
		07) Voice Module (number/type, delete)		
			Phone code	
			Voice language	
		08) Sounder (number/type, delete)		
			Partition(s)	
			Sound(s)	
		09) Bus Zone (number/type, delete)		
		10) GSM (number/type, delete)		
		11) Bus Zone Expander (number/type, delete)		
		12) LRT (number/type, delete)		
		13) COB		
	3) Testing			
		1) Bus Test		
		2) Bus Scan		
	4) Bus Speed			
		1) Normal		
		2) Fast		

2) Wireless Device			
	1) RX Calibration		
		Choose receiver	
			Re-calibrate?
	2) Allocation		
		1) By RF	
			1) Zone
			2) Keyfob
			3) Keypad
			4) Sounder
		2) By code	
			1) Zone
			2) Keyfob
			3) Keypad
			4) Sounder
	3) Delete		
8) Devices			
1) Keypad			
	1) Label		
		Assign to partition	
		Masking	
		1) Emergency	
		2) Multi view	
		3) Exit Beeps	
		4) Supervision	
	2) Partition		
		Assign to partition	
		Masking	
		1) Emergency	
		2) Multi view	
		3) Exit Beeps	
		4) Supervision	
	3. Masking		
		Masking	
		1) Emergency	
		2) Multi view	
		3) Exit Beeps	
		4) Supervision	
	4) Controls		
		1) Emergency	
		2) Multi view	
		3) Exit Beeps	
		4) Supervision	
	5) Serial Number		
	6) Function Key		
		1)Disable	
		2)Panic	
		3)MS Listen Talk	
	7) UO Key 1		

	8) UO Key 2			
	9) UO Key 3			
2) Keyfob (1-Way)	Button 1—4 options:			
	0) None			
	1) Arm			
	2) Disarm			
	3) Stay			
	4) Group			
	5) UO			
	6) Panic			
2) Keyfob (2-Way)	Button 1—8:			
	1) Label			
	5) Serial No.			
	6) Masking			
	7) Controls→Panic			
	8) PIN Code			
	9–11) UO Key (1–3)			
3) Sounder	1) Parameter			
		01) Label		
		02) Masking		
		03) Strobe		
			1) Control	
				1) Always Off
				2) Follow Bell
				3) Follow Alarm
			2) Blink	
				1) 20[Times/Min]
				2) 30 [Times/Min]
				3) 40 [Times/Min]
				4) 50 [Times/Min]
				5) 60 [Times/Min]
			3) Arm Squawk (Strobe Squawk)	
		04) Siren LED		
			1) Always On	
			2) Always Off	
			3) Follow Arm	
			4) Follow Alarm	
		05) Battery Load Test		
			1) Never	
			2) Every 24 hours	
		06) Prox. Lvl Response		
		07) Volume		
			S=01 Volume Level 9 (0-9)	
		08) Lamp		
			1) Type	
			2) Brightness	

		09) Power Source		
			1) SAB	
			2) SCB	
		10) Siren Current		
			1) Low	
			2) Standard	
		11) Alarm Sound (1-4)		
		12) Serial Number		
		13) Supervision		
	2) Lamp Times			
		1) Lamp Start		
		2) Lamp Stop		
4) Proximity Reader				
	1) Masking			
	2) Controls			
		1) Instant arm		
		2) Show Ready		
		3) Show Arm		
		4) Show Stay		
		5) Show Bypass		
5) Power Supply				
	1) Masking			
	2) Controls			
		1) Bell / L Speak		
0) Exit				



Additional Installer Menus

Activities Menu				
Keypad Sound				
	Chime			
		Keypad Chime		
		Partition Chime		
	Buzzer On/Off			
Advanced...				
	Service Mode			
	MS Test			
Wi-Fi...				
	Wi-Fi Scan			
	Wi-Fi WPS Button			
Follow Me Menu				
Define				
View Menu				
Trouble				
Alarm Memory				
	All Partitions Disarmed			
Partition Status				
	(zone number)			
Zone Status				
	(zone number)			
Service Info				
	Installer			
	System Version			
	Serial Number			
	Panel ID			
	Cloud Status			
	WiFi Status			
Clock Menu				
Time and Date				
Scheduler				
	Weekly (schedules 1--64)			
		1) Arm/Disarm		
			1) ON/OFF	
			2) Partition	
			3) Arming Mode	
				1) Arm
				2) Stay
				3) Group (A, B, C, D)
			4) Day/ Time	
				1) Monday Arm/Disarm times
				2) Tuesday Arm/Disarm times

				3) Wednesday Arm/Disarm times
				4) Thursday Arm/Disarm times
				5) Friday Arm/Disarm times
				6) Saturday Arm/Disarm times
				7) Sunday Arm/Disarm times
				8) All Arm/Disarm times
			5) Label	
				Schedule label
			6) Inactive	
				Inactive Timer OFF/ON
		2) UO ON/OFF		
			1) ON/OFF	
				Schedule(s) ON/OFF
			2) Utility Outputs	
				Utility Outputs Y/N
			3) Day/Time	
				1) Monday Start/Stop times
				2) Tuesday Start/Stop times
				3) Wednesday Start/Stop times
				4) Thursday Start/Stop times
				5) Friday Start/Stop times
				6) Saturday Start/Stop times
				7) Sunday Start/Stop times
				8) All Start/Stop times
			4) Vacation	
				UO Vacation Y/N Vac.start/stop times
			5) Label	
				Schedule label
		3) USER LIMIT		
			1) ON/OFF	
				Schedule ON/OFF
			2) Users number	
				00) Grand Master Y/N
				(01-) User
			3) Day/Time	
				1) Monday Start/Stop times
				2) Tuesday Start/Stop times

				3) Wednesday Start/Stop times
				4) Thursday Start/Stop times
				5) Friday Start/Stop times
				6) Saturday Start/Stop times
				7) Sunday Start/Stop times
				8) All Start/Stop times
			4) Label	
				Schedule label
	One Time			
		Next Arm		
			Next Arm partition/s	
			Next Arm Time	
		Next Disarm		
			Next disarm partition/s	
			Next disarm time	
Vacation				
	Partitions			
		(partition number/s)		
	Dates			
		Start time & date		
		Stop time & date		
Event Log Menu				
Event/s				
	Event code/time/date			
Maintenance Menu				
Walk test				
	Full Walk Test			
		Results (per event)		
	Quick Walk Test			
		Results per zone		
Keypad test				
Siren test				
Strobe test				
Wireless test				
	Keyfobs			
		Communication Test		
		Battery Test		
	WL Sirens			
		Communication Test		
		Battery Test		
Diagnostics				
	Main battery test			
		0) Main Board		
		1) Siren 1		

		2) Siren 2		
	Zone Resistance			
	Bus Zones			
	Zone Expander			
		Select Zone Expander		
			Zone Exp. Diagnostics	
				Aux (VDC)
	Power Supply			
	Siren			
		Select Siren		
			Siren Diagnostics	
				Battery voltage [VDC]
				Battery load [VDC]
				Aux voltage [VDC]
				Bell current [A]
				Charge current [mA]
				Lamp current [mA]
			Siren Version	
			Siren Calibration	
				New threshold
	GSM			
		Signal (0–5)		
		Version		
		IMEI		
	IP			
		IP Address		
		MAC Address		
		WiFi MAC Address		
	WME Version			
	Panel Version			
	Voice Version			
	Keypad Version			
	LRT			
	W2W Zone Version			
	W2W KF Version			
	COB			
	BZE Version			
Macro Menu				
Macro (A, B, C, D)				
		Start/stop macro		
Standalone Keyfob Menu				
Select Receiver				
		New Keyfob		
		Start/stop Learn mode		
		Delete Keyfob		
		Start Erase mode		
		Delete All		

	UO Buttons			
--	------------	--	--	--



UKCA and CE RED Compliance Statement

Hereby, RISCO Group declares that this equipment is in compliance with the essential requirements of the UKCA Radio Equipment Regulations 2017 and CE Directive 2014/53/EU.

For the UKCA and CE Declaration of Conformity please refer to our website www.riscogroup.com

Standard Limited Product Warranty (“Limited Warranty”)

RISCO Ltd. (“RISCO”) guarantee RISCO’s hardware products (“Products”) to be free from defects in materials and workmanship when used and stored under normal conditions and in accordance with the instructions for use supplied by RISCO, for a period of (i) 24 months from the date of delivery of the Product (the “Warranty Period”). This Limited Warranty covers the Product only within the country where the Product was originally purchased and only covers Products purchased as new.

Contact with customers only. This Limited Warranty is solely for the benefit of customers who purchased the Products directly from RISCO or from an authorized distributor of RISCO. RISCO does not warrant the Product to consumers and nothing in this Warranty obligates RISCO to accept Product returns directly from end users who purchased the Products for their own use from RISCO’s customer or from any installer of RISCO, or otherwise provide warranty or other services to any such end user directly. RISCO’s authorized distributor or installer shall handle all interactions with its end users in connection with this Limited Warranty. RISCO’s authorized distributor or installer shall make no warranties, representations, guarantees or statements to its end users or other third parties that suggest that RISCO has any warranty or service obligation to, or any contractual privity with, any recipient of a Product.

Remedies. In the event that a material defect in a Product is discovered and reported to RISCO during the Warranty Period, RISCO shall accept return of the defective Product in accordance with the below RMA procedure and, at its option, either (i) repair or have repaired the defective Product, or (ii) provide a replacement product to the customer.

Return Material Authorization. In the event that you need to return your Product for repair or replacement, RISCO will provide you with a Return Merchandise Authorization Number (RMA#) as well as return instructions. Do not return your Product without prior approval from RISCO. Any Product returned without a valid, unique RMA# will be refused and returned to the sender at the sender’s expense. The returned Product must be accompanied with a detailed description of the defect discovered (“Defect Description”) and must otherwise follow RISCO’s then-current RMA procedure published in RISCO’s website at www.riscogroup.com in connection with any such return. If RISCO determines in its reasonable discretion that any Product returned by customer conforms to the applicable warranty (“Non-Defective Product”), RISCO will notify the customer of such determination and will return the applicable Product to customer at customer’s expense. In addition, RISCO may propose and assess customer a charge for testing and examination of Non-Defective Product.

Entire Liability. The repair or replacement of Products in accordance with this Limited Warranty shall be RISCO’s entire liability and customer’s sole and exclusive remedy in case a material defect in a Product is discovered and reported as required herein. RISCO’s obligation and this Limited Warranty are contingent upon the full payment by customer for such Product and upon a proven weekly testing and examination of the Product functionality.



Limitations. This Limited Warranty is the only warranty made by RISCO with respect to the Products. The warranty is not transferable to any third party. To the maximum extent permitted by applicable law, this Limited Warranty shall not apply and will be void if: (i) the conditions set forth above are not met (including, but not limited to, full payment by customer for the Product and a proven weekly testing and examination of the Product functionality); (ii) if the Products or any part or component thereof: (a) have been subjected to improper operation or installation; (b) have been subject to neglect, abuse, willful damage, abnormal working conditions, failure to follow RISCO's instructions (whether oral or in writing); (c) have been misused, altered, modified or repaired without RISCO's written approval or combined with, or installed on products, or equipment of the customer or of any third party; (d) have been damaged by any factor beyond RISCO's reasonable control such as, but not limited to, power failure, electric power surges, or unsuitable third party components and the interaction of software therewith or (e) any failure or delay in the performance of the Product attributable to any means of communication provided by any third party service provider, including, but not limited to, GSM interruptions, lack of or internet outage and/or telephony failure. BATTERIES ARE EXPLICITLY EXCLUDED FROM THE WARRANTY AND RISCO SHALL NOT BE HELD RESPONSIBLE OR LIABLE IN RELATION THERETO, AND THE ONLY WARRANTY APPLICABLE THERETO, IF ANY, IS THE BATTERY MANUFACTURER'S WARRANTY. RISCO does not install or integrate the Product in the end user's security system and is therefore not responsible for and cannot guarantee the performance of the end user's security system which uses the Product or which the Product is a component of.

This Limited Warranty applies only to Products manufactured by or for RISCO. Further, this Limited Warranty does not apply to any software (including operating system) added to or provided with the Products or any third-party software, even if packaged or sold with the RISCO Product. Manufacturers, suppliers, or third parties other than RISCO may provide their own warranties, but RISCO, to the extent permitted by law and except as otherwise specifically set forth herein, provides its Products "AS IS". Software and applications distributed or made available by RISCO in conjunction with the Product (with or without the RISCO brand), including, but not limited to system software, as well as P2P services or any other service made available by RISCO in relation to the Product, are not covered under this Limited Warranty. Refer to the Terms of Service at: www.riscogroup.com/warranty for details of your rights and obligations with respect to the use of such applications, software or any service. RISCO does not represent that the Product may not be compromised or circumvented; that the Product will prevent any personal injury or property loss by burglary, robbery, fire or otherwise, or that the Product will in all cases provide adequate warning or protection. A properly installed and maintained alarm may only reduce the risk of a burglary, robbery or fire without warning, but it is not insurance or a guarantee that such will not occur or will not cause or lead to personal injury or property loss. CONSEQUENTLY, RISCO SHALL HAVE NO LIABILITY FOR ANY PERSONAL INJURY, PROPERTY DAMAGE OR OTHER LOSS BASED ON ANY CLAIM AT ALL INCLUDING A CLAIM THAT THE PRODUCT FAILED TO GIVE WARNING.



EXCEPT FOR THE WARRANTIES SET FORTH HEREIN, RISCO AND ITS LICENSORS HEREBY DISCLAIM ALL EXPRESS, IMPLIED OR STATUTORY, REPRESENTATIONS, WARRANTIES, GUARANTEES, AND CONDITIONS WITH REGARD TO THE PRODUCTS, INCLUDING BUT NOT LIMITED TO ANY REPRESENTATIONS, WARRANTIES, GUARANTEES, AND CONDITIONS OF MERCHANTABILITY, FITNESS FOR A PARTICULAR PURPOSE, TITLE AND WARRANTIES AGAINST HIDDEN OR LATENT DEFECTS, TO THE EXTENT PERMITTED BY LAW. WITHOUT LIMITING THE GENERALITY OF THE FOREGOING, RISCO AND ITS LICENSORS DO NOT REPRESENT OR WARRANT THAT: (i) THE OPERATION OR USE OF THE PRODUCT WILL BE TIMELY, SECURE, UNINTERRUPTED OR ERROR-FREE; (ii) THAT ANY FILES, CONTENT OR INFORMATION OF ANY KIND THAT MAY BE ACCESSED THROUGH THE PRODUCT SHALL REMAIN SECURED OR NON DAMAGED. CUSTOMER ACKNOWLEDGES THAT NEITHER RISCO NOR ITS LICENSORS CONTROL THE TRANSFER OF DATA OVER COMMUNICATIONS FACILITIES, INCLUDING THE INTERNET, GSM OR OTHER MEANS OF COMMUNICATIONS AND THAT RISCO'S PRODUCTS, MAY BE SUBJECT TO LIMITATIONS, DELAYS, AND OTHER PROBLEMS INHERENT IN THE USE OF SUCH MEANS OF COMMUNICATIONS. RISCO IS NOT RESPONSIBLE FOR ANY DELAYS, DELIVERY FAILURES, OR OTHER DAMAGE RESULTING FROM SUCH PROBLEMS. RISCO WARRANTS THAT ITS PRODUCTS DO NOT, TO THE BEST OF ITS KNOWLEDGE, INFRINGE UPON ANY PATENT, COPYRIGHT, TRADEMARK, TRADE SECRET OR OTHER INTELLECTUAL PROPERTY RIGHT IN ANY EVENT RISCO SHALL NOT BE LIABLE FOR ANY AMOUNTS REPRESENTING LOST REVENUES OR PROFITS, PUNITIVE DAMAGES, OR FOR ANY OTHER INDIRECT, SPECIAL, INCIDENTAL, OR CONSEQUENTIAL DAMAGES, EVEN IF THEY WERE FORESEEABLE OR RISCO HAS BEEN INFORMED OF THEIR POTENTIAL.



Contacting RISCO Group

RISCO Group is committed to customer service and product support. You can contact us through our website (www.riscogroup.com) or at the following RISCO branches:

Belgium (Benelux)

Tel: +32-2522-7622

support-be@riscogroup.com

Israel

Tel: +972-3-963-7777

support@riscogroup.com

United Kingdom

Tel: +44-(0)-161-655-5500

support-uk@riscogroup.com

China (Shanghai)

Tel: +86-21-52-39-0066

support-cn@riscogroup.com

Italy

Tel: +39-02-66590054

support-it@riscogroup.com

France

Tel: +33-164-73-28-50

support-fr@riscogroup.com

Spain

Tel: +34-91-490-2133

support-es@riscogroup.com

This RISCO product was purchased from:

